

LS-51T

The LS-51T is a high output acoustic box, which is compound by a 5" woofer and a 1" tweeter.

The enclosure is made of ABS plastic halogens free and low resonance.

The metallic grille included on is acoustically transparent.

The high quality components, which compound this box, allow a high sensitivity.

High pass filter included. There are some kinds of brackets in order to mounting it. They could be adjustable or fixed.

Features LS-51T:

- High output: 89 db (1 W, 1 m).
- Excellent quality of voice and music transmission.
- Excellent quality of voice and music transmission.
- Colours: white RAL 9003
- Power taps selector.
- Connector by pressure.

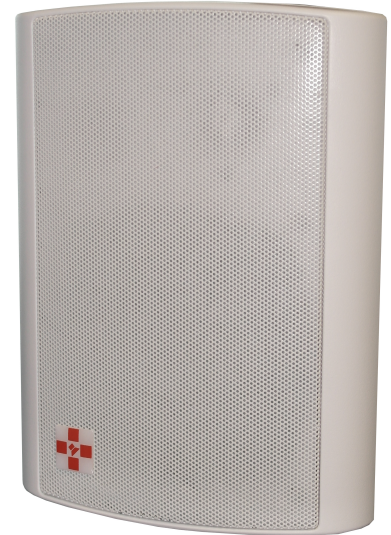

Technical specifications:

Model	LS-51T
Power supply	30 W RMS
Frequency response I/O	200 Hz – 18 kHz. (+/- 10 dB)
Sensitivity	89 dB +/- 3 dB (1 W, 1 m)
Speaker impedance	8 ohm
Dispersion	90° horizontal / 80° vertical
Colour	White
Transformer 70 V / 100 V	30 W, 15 W, 7.5 W, 3.75 W @ 100 V 15 W, 7.5 W, 3.75 W, 1.9 W @ 70 V
Connector	2 x pressure
Speaker	5" woofer and 1" tweeter
Bracket (optional)	Adjustable with wall or ceiling fixing
Dimensions (width x height x depth)	162 x 242 x 182 mm
Weight	2,5 kg

LS-51T

Additional information:

Frequency response:

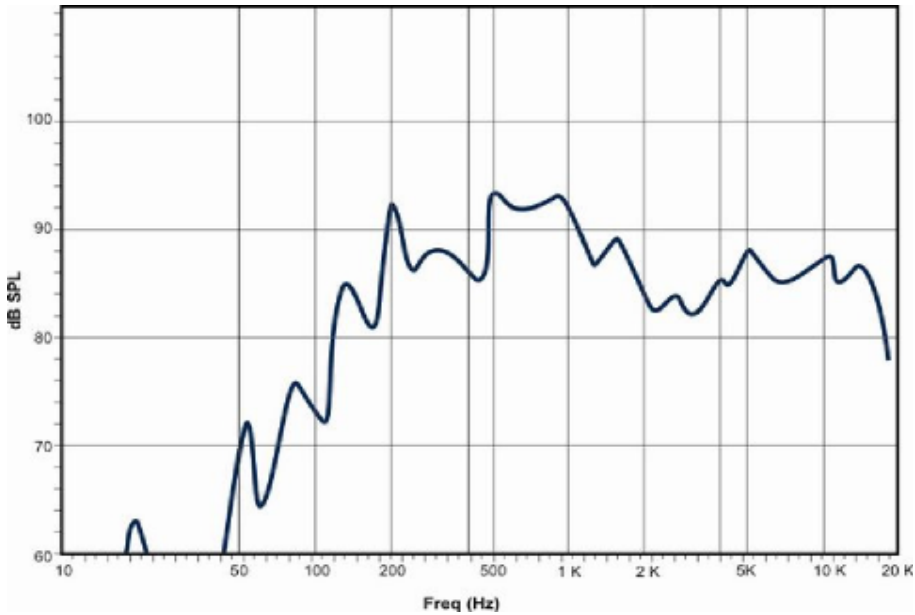

Impedance:

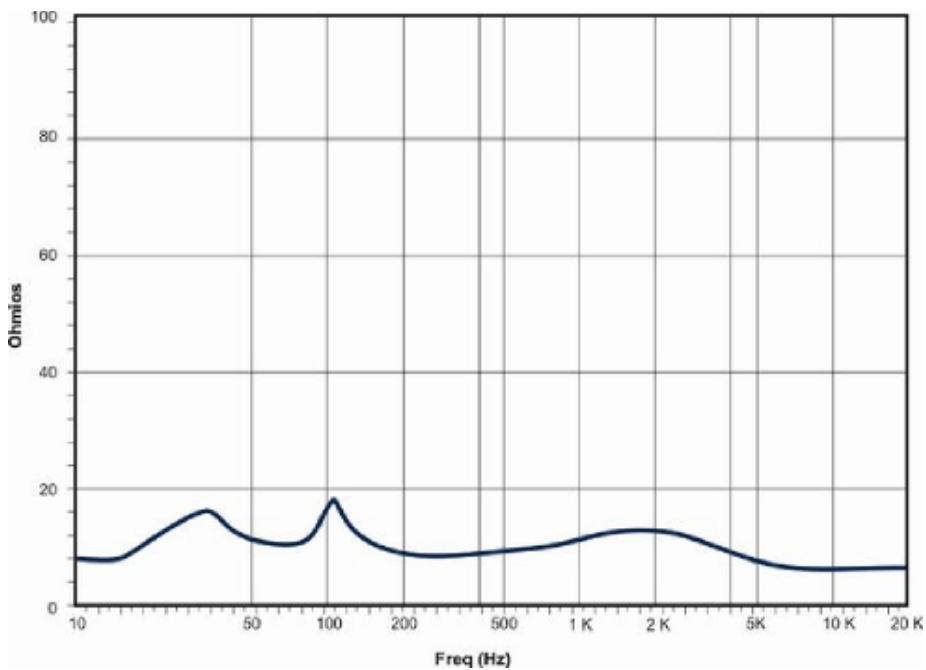

LS-51T

Vertical polar diagram:

Frequency: 1 KHz

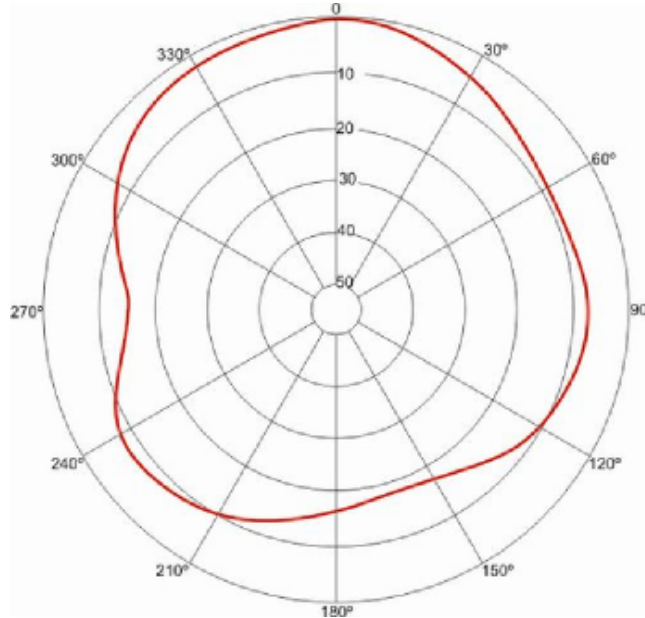

Horizontal polar diagram :

Frequency: 1 KHz

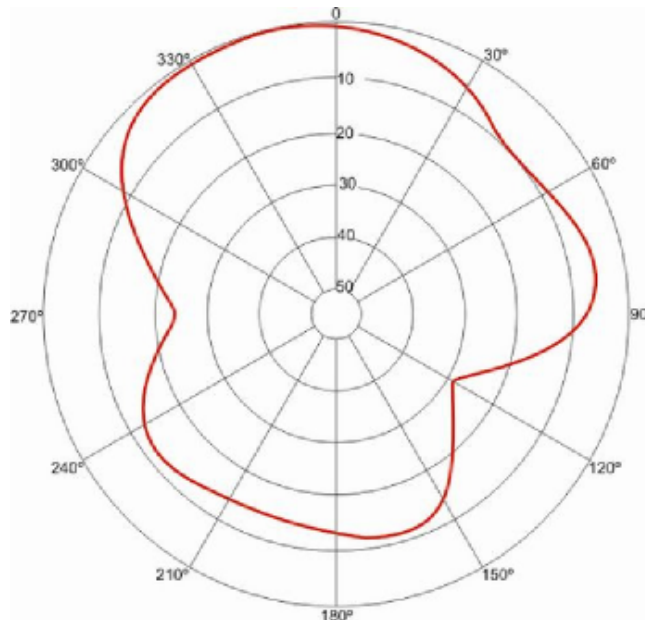

LS-51T

Mechanical drawings:

Dimensions in mm

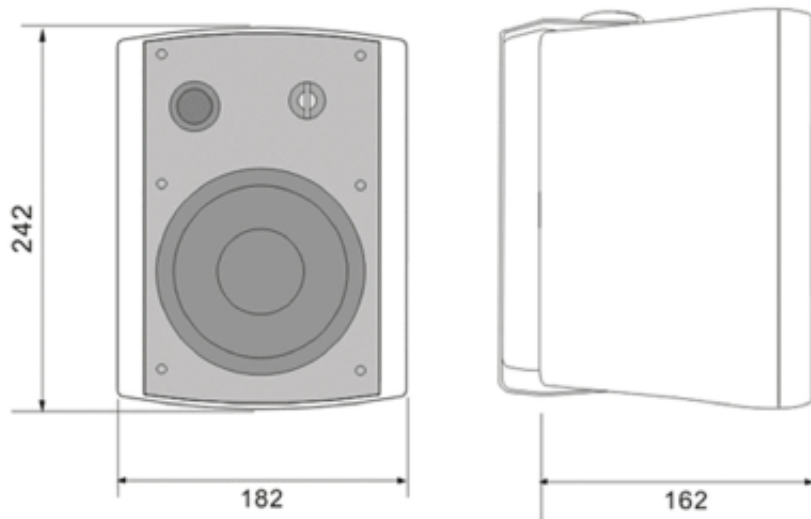

Horizontal or vertical installation:

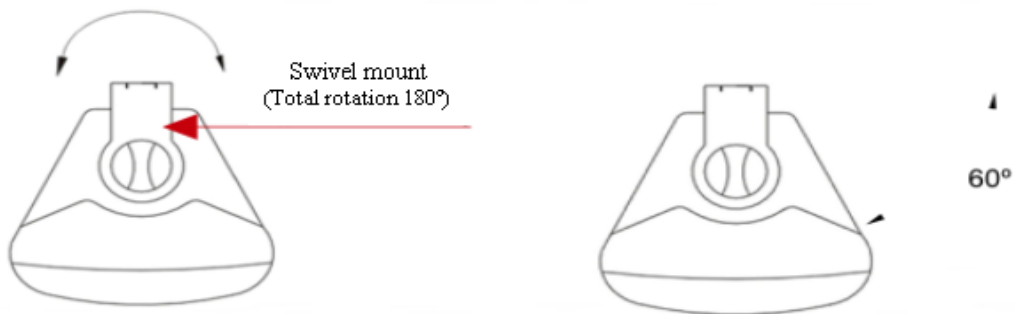

Horizontal position

Vertical position



LS-51T

Power taps selector:

Power taps selection for 70/100 V lines

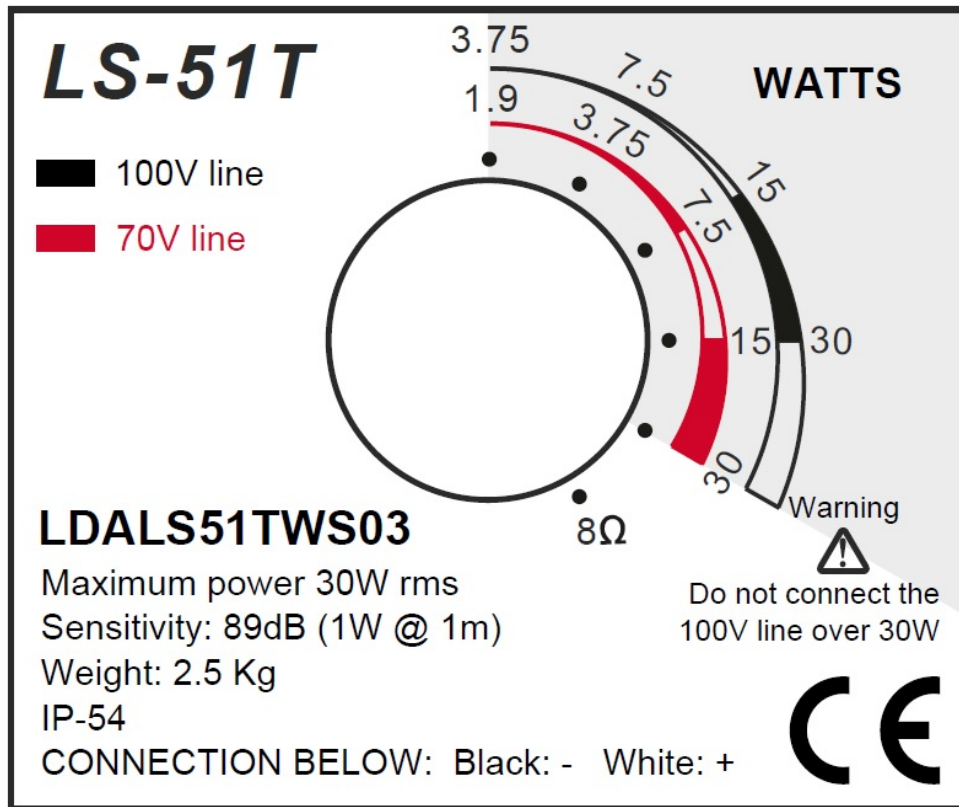

LS-51T

SPECIFICATIONS FOR ENGINEERS AND ARCHITECTS

The speaker will be compound by a 5" woofer, a 1" tweeter and a high pass filter. It will be connected to 70 and 100 V lines. The range of frequencies that it must cover will be comprised between 200 Hz and 18 KHz with a 89 dB sensitivity measured to 1 W and 1 m.

The speaker will be installed horizontally and vertically, where the dispersion will be 90° and 80° respectively.

The enclosure will be made in ABS with a metallic grille transparent acoustically. The available colors will be white (RAL 9003).

The shape of the box will be a 1/6 spare part of a cylinder. It will be provided by an adjustable bracket, which has U shape and could rotate until 90° angle.

The product fulfills the CE marked.

Warranty	2 years
Product Code	LDALS51TS03

Sound tests:

1. Power

Pink noise is introduced and amplified through the whole band width obeying the standard IEC 60268-5. If the maximum power of the speaker is reached, the noise is cut. Then, the speaker is checked. It must not present visible damages or loss of features after 100 hours of working.

2. Sensitivity, frequency range and impedance.

It is introduced several sinusoidal impulses which have different frequency to 1 W of power level from the nominal impedance of the speaker. The average sound pressure level (dB-SPL) is measured to 1 meter of distance with regard to the speaker in a anechoic environment.