

# NEO

## User's Manual



EN 54-16 certified PA/VA system LDA NEO

## SAFETY INSTRUCTIONS

Please read carefully these safety instructions.

1. Keep this User Manual for future reference.
2. Power connectors must stay accessible for disconnection and power cord must be placed where people will not step or stumble. Unplug the equipment from the AC/DC before cleaning.
3. The equipment must not be exposed to water and water containers must not be placed over it. Do not use liquid or sprayed detergent for cleaning. Do not expose this equipment to humid areas.
4. Do not place naked flames near the equipment.
5. Install this equipment in a safe surface. If the equipment is not in a safe surface, it may fall and be damaged.
6. The openings on the enclosure are for air convection. Do not allow overheat. **DO NOT COVER THE OPENINGS.** Leave at least 5cm of space at the sides for its correct ventilation.
7. Never open the equipment. For safety reasons, the equipment should only be opened by qualified personnel.
8. The equipment must be plugged into a grounded outlet.
9. Pay attention to connection polarity when operating the machine with a power supply (DC). Reverse connection polarity may cause damage to the equipment, or to the power supply.
10. Let staff check the equipment if any of these situations occur:
  - a) The power cord or power plug is damaged.
  - b) Liquid has penetrated inside the equipment.
  - c) The equipment has been exposed to moisture.
  - d) The equipment does not work well or does not work according to the instruction manual.
  - e) The equipment was dropped and damaged.
  - f) If the equipment has obvious signs of damage.
11. Cabling must be done only by trained personnel. Disconnect the audio inputs and outputs while making connections or disconnect the equipment from the power supply. Be sure to use the proper cables to make the connections.

# Index

<b>1 INTRODUCTION</b> .....	<b>1</b>
<b>2 DESCRIPTION</b> .....	<b>2</b>
<b>2.1 INDICATORS</b> .....	<b>2</b>
2.1.1 GENERAL STATUS INDICATORS .....	2
2.1.2 CHANNEL STATUS INDICATORS.....	2
2.1.3 SUPERVISED FUNCTION INDICATORS.....	3
2.1.4 EMERGENCY SOURCES INCDICATORS.....	3
<b>2.2 CONTROLS</b> .....	<b>4</b>
2.2.1 DIRECT ACCESS CONTROLS.....	4
2.2.2 SCROLL BUTTONS.....	4
2.2.3 TEST.....	4
2.2.4 RESET/ RST.....	4
2.2.5 ACK.....	5
2.2.6 CONTROL WINDOW.....	5
2.2.7 ZONE SELECTION WINDOW.....	5
<b>2.3 USER PROFILES - ACCESS LEVEL. PASSCODE</b> .....	<b>7</b>
2.3.1 ACCESS LEVEL 1 .....	7
2.3.2 ACCESS LEVEL 2.....	7
2.3.3 ACCESS LEVEL 3.....	7
<b>2.4 INPUTS Y OUTPUTS</b> .....	<b>8</b>
2.4.1 EMERGENCY POWER SUPPLY MONITORING.....	8
2.4.2 EMERGENCY ACTIVATION INTERFACE.....	9
2.4.3 SPEAKER LINE DEVICES INTERFACE.....	10
2.4.4 EXTERNAL SYSTEMS SLOT INTERFACE.....	11
2.4.5 POWER SUPPLY.....	14
2.4.6 SPEAKERS LINES.....	15
2.4.7 INPUTS AND OUTPUTS OF AUDIO SOURCES.....	16
2.4.8 SYSTEM INTEGRATION PORTS.....	17
<b>3 FUNCTIONING</b> .....	<b>19</b>
<b>3.1 SYSTEM BOOTING</b> .....	<b>19</b>
<b>3.2 EMERGENCY</b> .....	<b>19</b>
3.2.1 ACTIVATING THE EMERGENCY STATE.....	19
3.2.2 ACTIVATING THE VOICE ALARM.....	19
3.2.3 STOPPING VOICE ALARM.....	20
3.2.4 DEACTIVATING THE EMERGENCY STATE.....	20
3.2.5 EMERGENCY STATE LOG.....	20
3.2.1 VOICE EVACUATION ZONE VOLUME ADJUSTMENT .....	20
<b>3.3 FAILURE</b> .....	<b>21</b>
3.3.1 FAILURE STATE LOG.....	21
3.3.1 RESET FAILURE'S STATE.....	21
<b>3.4 DESARMING</b> .....	<b>21</b>
3.4.1 DEACTIVATING/ ACTIVATING A ZONE.....	21
3.4.2 DISARM LOG.....	21
<b>3.5 PA MODE</b> .....	<b>21</b>
3.5.1 ZONE VOLUME SETTING.....	22
3.5.2 ROUTE SOURCES.....	23
3.5.3 AVANCED OPTIONS.....	24
3.5.4 AVANCED OPTIONS. AUDIO INPUT.....	25
3.5.5 AVANCED OPTIONS. AUDIO OUTPUT.....	26
3.5.6 AVANCED OPTIONS. MONITOR.....	27
3.5.1 AVANCED OPTIONS. MESSAGES.....	28
3.5.1 ADVANCED OPTIONS. LOAD PRESET.....	29
3.5.2 ADVANCED OPTIONS. SYSTEM .....	29
<b>4 CONNNECTION AND SETUP</b> .....	<b>32</b>
<b>4.1 EMERGENCY SUPPLY SYSTEM</b> .....	<b>32</b>
<b>4.2 PAGING MICROPHONES AND PA ELEMENTS (ACSI BUS)</b> .....	<b>33</b>
<b>4.3 FLEXNET CONNECTION</b> .....	<b>33</b>
<b>4.4 VOICE EVACUATION ZONES</b> .....	<b>34</b>
<b>4.5 BACK-UP AMPLIFICATION</b> .....	<b>34</b>
<b>4.6 SPEAKER LINES</b> .....	<b>35</b>
4.6.1 LINE CABLING. STANDARD MODE.....	35
4.6.2 LINE CABLING. AB MODE.....	35
4.6.3 SUPERVISION OF SPEAKER CONNECTIONS.....	36
4.6.4 END OF LINE DEVICES.....	36
<b>4.7 VOLUME CONTROLLERS</b> .....	<b>39</b>
<b>5 FAILURE DETECTION</b> .....	<b>40</b>
<b>5.1 SPEAKERS LINE</b> .....	<b>40</b>
<b>5.2 TRANSMISSION LINE WITH CIE</b> .....	<b>40</b>

5.3 PROTECTION DEVICES .....	40
5.4 POWER SUPPLY .....	40
5.5 LINK.....	40
5.6 SYSTEM.....	41
6 MAINTENANCE INSTRUCTIONS .....	42
7 TECHNICAL FEATURES.....	43
8 Appendix A: EN 54-16 features.....	46
9 Appendix B: LOG Content.....	48
9.1 STATE OF EMERGENCY LOG.....	48
9.2 STATE OF FAILURE LOG.....	48
9.3 STATE OF DISARMED LOG.....	48
10 Appendix C: Cabling section for speaker lines.....	49

## 1 INTRODUCTION

The PA/VA system LDA NEO is certified according to EN 54-16, ensuring a safe and controlled emergency evacuation. Its high performance, versatility and audio quality make it also a powerful and cost-effective background music and paging system for all types of facilities.

This document is valid for the following equipment of the NEO series:

- **NEO8060.** Main system controller. Includes all the main functions required for the PA/VA system. Includes 8 amplifiers/zones of 120W.
- **NEO8250E.** System Extension that includes 8 amplifiers/zones of 250W.
- **NEO4250E.** System Extension that includes 4 amplifiers/zones of 250W.
- **NEO4500E.** System Extension that includes 4 amplifiers/zones of 500W.
- **NEO4500LE.** System Extension that includes 4 amplifiers/zones of 500W for low impedance speaker lines (8 and 4 Ohms)

NOTE: This document has been revised for the Firmware version v2.25.xx.28.

Other equipment referenced in this document are:

- LDANEOTFL. End-of-line (EOL) device.
- LDAMPS-8Z. Expandable 8-zone microphone.
- LDAVAP-1. Fireman panel with optional zone selection.

## 2 DESCRIPTION

The main controller of the PA/VA system manages all the audio inputs of the system, either conventional or emergency inputs, and routes them to the existing zones. The controller NEO, follows all the requirements in accordance with EN 54-16 and EN 60849 normatives.

In order to scale the system there are different NEO-Extension models that can be connected to the main controller by redundant Ethernet connection. They expand the system in number of zones, amplifier channels and available lines including all the necessary functions, being certified elements of the EN 54-16 system.

### 2.1 INDICATORS

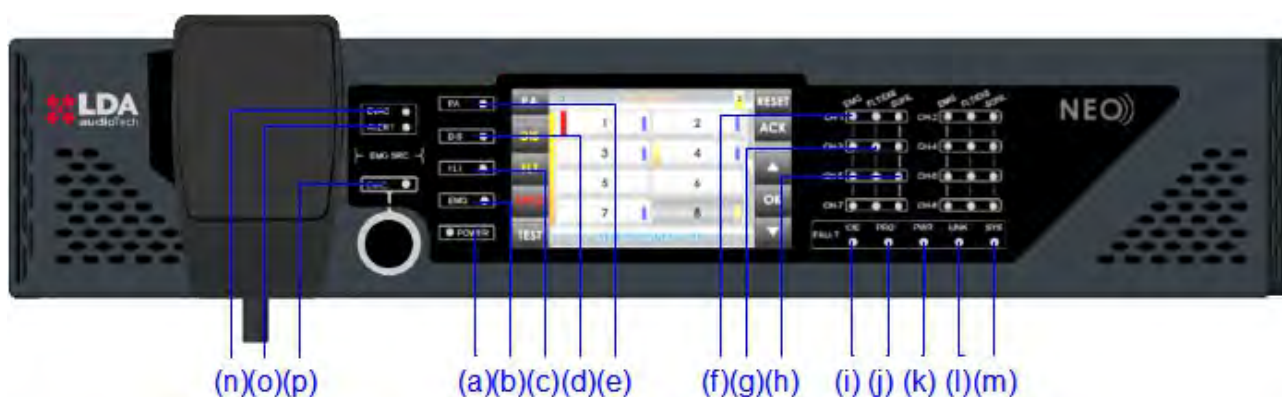

Picture 1: Indicators

#### 2.1.1 GENERAL STATUS INDICATORS

Status indicators show at all times the operating condition of the equipment or system. They are located at the left of the screen.

**a) POWER: "POWER". Green**

Active (on) when the unit is powered from any of the power supply sources.

**b) EMG: "EMERGENCY". Red**

Active (on) when the equipment is in a state of emergency operation (voice alarm) by manual activation or automatic activation from the CIE, at any of the voice alarm zones.

Simultaneously once the indicator is switched on, it will emit a continuous audible warning. This warning can be silenced by pressing the touch-button "ACK" (Acknowledge), or automatically when using the emergency microphone.

**c) FLT: "FAULT". Amber**

Active (on) when the equipment is in a fault state. This indicator is activated automatically upon detection of failure of any supervised functions.

Simultaneously, the LED indicator and an audible warning will be issued intermittently. This warning can be silenced by pressing the touch-button "ACK", or automatically when using the emergency microphone.

**d) DIS: "DISARMED" / "DESACTIVADO". Amber**

Active (on) when any zone from the voice alarm zones is disabled.

**e) PA: "PUBLIC ADDRESS". White**

Active when the equipment is not in a state of emergency.

#### 2.1.2 CHANNEL STATUS INDICATORS

The channel status indicators show at all times the channel operating state or condition.

**(f) EMG: "EMERGENCY" . Red**

Active (on) when the equipment is in a state of emergency operation (voice alarm) or by manual or automatic activation from the CIE, of any of the voice alarm zones. When the system is in a state of emergency and it is broadcasting a spoken voice, either through the emergency microphone or by a prerecorded evacuation message, the indicator light will flash.

**(g) FLT/DIS: "FAULT / DISARMED" . Amber**

Active (on) when the voice evacuation channel is turned off.

Active (flashing) when a fault is detected on a voice evacuation channel. This indicator is activated automatically upon detection of failure of any supervised functions in the channel. If none of the indicators of general supervised function is on, it will indicate a fault in the speaker's line. Restart the fault condition.

**(h) SIGNAL: "SIGNAL" . Green**

Active (on) when it detects an amplifier channel output signal from the corresponding voice evacuation zone. The minimum level at which the indicator lights is -50dB.

**2.1.3 SUPERVISED FUNCTION INDICATORS**

Supervised Functions indicators show the faults that affect the general system functions.

**i) CIE: "CIE" / "ECI"**

Active (on) when a failure occurs in the transmission line between the CIE and the system. Reset fault condition. If fault the persists, see chapter 5.2 for its resolution. Amber colour.

**j) PROTECT: "PROTECTION"**

Active (on) when any of the system protection devices are active. Restart the fault condition. Reset fault condition. If the fault persists, see chapter 5.3 for its resolution. Amber colour.

**k) POWER: "POWER" / "ALIMENTACIÓN"**

Active (on) when there is a power failure in the system. It may be due to a failure at the main power supply or at the emergency power supply. Reset fault condition. If the fault persists, see chapter 5.4 for its resolution. Amber colour.

**l) LINK: "LINK" / "ENLACE"**

Active (on) when there is a link failure between the equipment, and some elements of the distributed system. Reset fault condition. If the fault persists, see chapter 5.5 for its resolution. Amber colour.

**m) SYSTEM: "SYSTEM" / "SISTEMA"**

Active (on) when there is a failure in the execution of the equipment's software, or in its memory. Reset fault condition. If the fault persists, see chapter 5.6 for its resolution. Amber colour.

**2.1.4 EMERGENCY SOURCES INCDICATORS**

Emergency sources indicators indicate the operating status of prerecorded messages, and the emergency microphone.

**(n) EVAC: "EVACUATION"**

Active (on) when the evacuation message is being broadcast in the selected voice alarm zone. Red colour.

**(o) ALERT: "ALERT"**

Active (on) when the alert message is being broadcasted in the selected voice alarm zone. Amber colour.

(p) EMIC: “EMERGENCY MICROPHONE”

Active (on) when the microphone is available to perform an emergency evacuation in the selected zones. If the indicator is off, wait for it to be turned on, a warning sound signal might be played. Amber colour.

## 2.2 CONTROLS

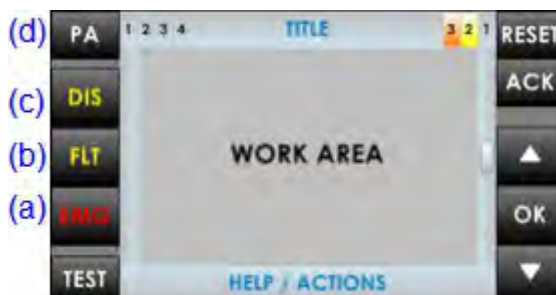

Picture 2: Controls

### 2.2.1 DIRECT ACCESS CONTROLS

These controls are located on the left side of the screen. They allow direct access to the notification windows of the active states. They show extended information about operating status and available options.

a) EMG: “EMERGENCY”

It allows access to emergency status menu. When the equipment or system is in this state, you will enter directly to the window with extended information about the state of emergency. To continue operating the equipment, press the "BACK" button.

b) FLT: “FAULT”

It allows access to the window of extended information about the fault state. Faults are displayed while the fault is not restarted, and up to 5 minutes after a reboot had occurred.

c) DIS: “DISARMED”

Accesses the disarmed menu . If there is a disabled zone, it will go directly to the window with extended information about the disable state.

d) PA / BACK: “PA/BACK”

It allows access to the PA menu when the equipment is not in a state of emergency, or failure.

It also allows the go-back function for navigation through the menus . The button "PA" will change to "BACK" button when the option is available again.

### 2.2.2 SCROLL BUTTONS

The scroll buttons are situated to the right side of the screen. They allow a scroll up / down within the windows displayed on the screen. It includes the "OK" button for operations that require confirmation.

### 2.2.3 TEST

The "TEST" button is located under the direct access controls. It allows to check the correct functioning of all indicators of the equipment. While the "TEST" button is being pressed it will turn on simultaneously , all the indicators, and an audible warning will be emitted. The screen will go into test mode. Once the button is released, the test will end. During the testing process all manual controls will be inactive. If they receive a signal from the CIE, for the activation of an emergency warning, the test will end.

### 2.2.4 RESET/ RST

The "RESET" button is located on the top right side of the screen. The "RESET" button resets the operating condition of the equipment when it is in a state of emergency or fault.

NOTE: If pushed twice in an interval of time less than 10 seconds, it will perform a software reset of the control module of NEO and its extensions. This action stops the execution of events, stops the microphones, playback of pre-recorded messages, etc.



### 2.2.5 ACK

The button " ACK " is situated under the button "RESET " on the right side of the screen. It allows the confirmation that the emergency mode or fault status indication has been acknowledged. By pressing it, the emergency or fault audible beep will be muted.

### 2.2.6 CONTROL WINDOW

The following describes the information that, continuously, can be viewed in the control window.

#### (a) NAVIGATION LEVEL

In the upper right side there is the menu level indicator in which the user is located. As we examine the menu it displays a higher level.

#### (b) TITLE

On the top of the window, it indicates the title of the section in which the user is operating.

#### (c) ACCESS LEVEL

Located in the upper right corner of the screen, it indicates the current access level (see 2.3).

#### (d) WORKING AREA

The central area of the screen will show the information or controls that are available to the user.

#### (e) LEFT BAR

Indicated by different colors, and along with the title, the menu in which the user is working. For emergency is red and for fault or disarmed zones is yellow.

#### (f) SCROLL BAR

At some windows this item may appear. It indicates that there are more objects to be displayed in the same window upwards or downwards. To access them, use the scroll buttons (see 3.2.2.).

The scroll bar can have three positions, top, middle or bottom, indicating, beginning, middle and end area respectively.

#### (g) HELP / ACTION

In the lower area of each window there is a help text indicating the next step to be performed by the user.

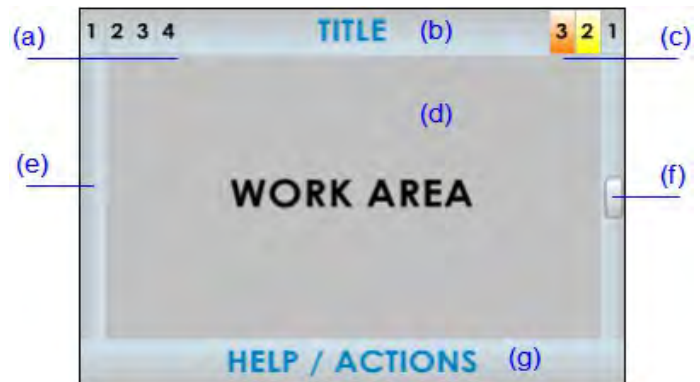

Picture 3: Control window

### 2.2.7 ZONE SELECTION WINDOW

In the zone selection window, over the zone/zones to make a selection. If you click on a selected zone, it will be deselected. When the zone is selected, the button will show a band. There may be zones that are not displayed on screen, to scroll through the zone selection window, use the scroll controls, located at the right side of the screen. On the right side of the window, the scroll bar indicates the current position in the window (see 2.2.6).

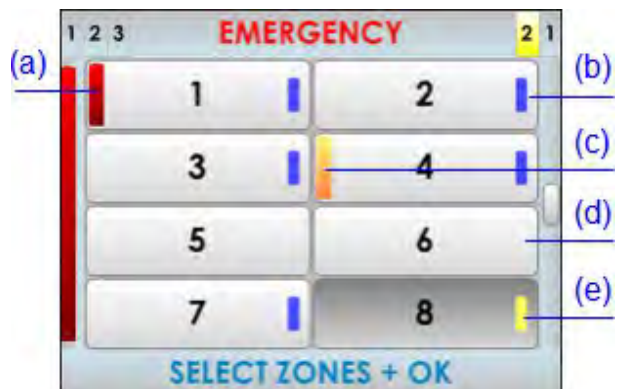

Picture 4: Zone selection window

Once the selection has been made, press the "OK" control to confirm navigation, pressing the "BACK" button, the selection will be cleared. If you did not select any zone, and press "OK", and the equipment / system will perform an automatic selection of all zones.

In each zone depicted on screen, it is indicated the state of the zone. It will be identified as follows:

**(a) ZONE IN STATE OF EMERGENCY**

Red box on the left side of the zone button. In Picture 4, zone 1

**(b) SELECTED ZONE**

Selection band in the right side. In Picture 4, zones 1, 2, 3, 4 and 7

**(c) ZONE INDICATING FAULT**

Yellow rectangle on the left side of the zone button. In Picture 4 zone 4

**(d) ZONA NO SELECCIONADA**

No selection band. In Picture 4, zones 5 and 6. Zone 8 can not be selected by default once disarmed (see 3.4).

**(e) DISARMED ZONE**

Disabled zone. Yellow band on the right side. The button will be a dark-colored area in Picture 4 zone 8

## 2.3 USER PROFILES - ACCESS LEVEL. PASSCODE

The access levels define the different user profiles that can operate the equipment / system. Each of the access levels, provides permissions to different menu items, level 1 having the lowest, and level 3 the highest number of options available.

To access a specific level of access, you must perform access control satisfactorily. Once done, you can navigate the options, until you return to the home screen, or do not perform any operation for more than 90 seconds.

The way to perform access control can be set in each of the levels. It is possible to choose from confirmation mode, or access via 4-digit passcode with the configuration application.



Picture 5: Types of Control Access Windows

### 2.3.1 ACCESS LEVEL 1

The access level 1 corresponds to the general user profile, or people who have a general responsibility for security supervision, which may initially respond to an emergency status, or failure.

### 2.3.2 ACCESS LEVEL 2

The access level 2 corresponds to a security manager profile who has specific training to operate the equipment / system in the states of "PA", "Emergency", "Failure message" and "Disarmed".

### 2.3.3 ACCESS LEVEL 3

The access level 3 corresponds to the administrator profile, who has specific training to modify the system configuration and perform the maintenance, according to the instructions and information presented in this manual.

## 2.4 INPUTS Y OUTPUTS

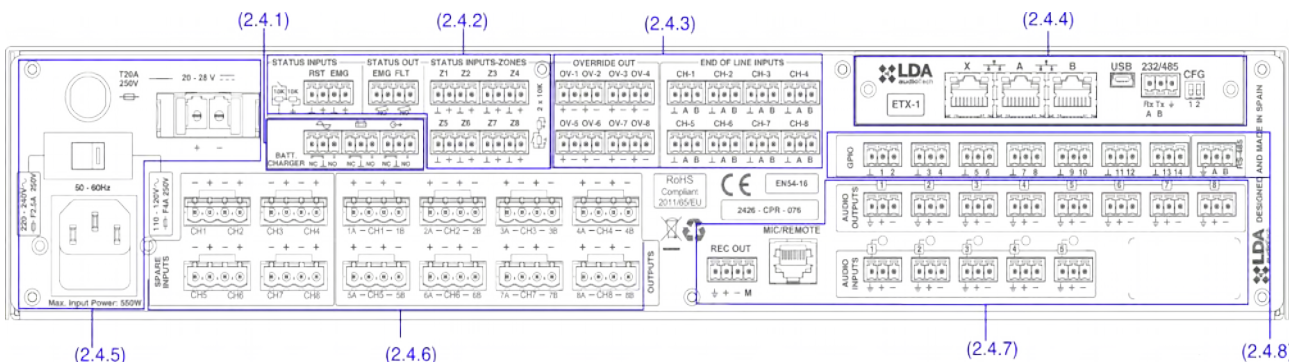

Picture 6: Inputs and Outputs

In this chapter are described the rear connectors of the NEO series equipment. Depending on the model, the equipment will or will not include some of the types described in this section and quantity may vary.

The monitoring interfaces for emergency power supply and general inputs/outputs for activating the emergency, are available in all equipment of the NEO series. From the configuration software it is possible to select which ones will be used.

### 2.4.1 EMERGENCY POWER SUPPLY MONITORING

#### (a) MONITORING INPUTS FOR THE EMERGENCY POWER SUPPLY

It allows the connection to the system of the status-output signals from the emergency back-up power supply. It has three double contact closure inputs: main power supply failure, battery failure, failure in any of the emergency power outputs.

Each input has three terminals: Normally Closed (NC), Common and Normally Open (NO). To activate any of the fault signals, a contact closure input on NO should be produced, and simultaneously an opening of a contact closure on NC input. In any other case, it will detect fault in the connection.

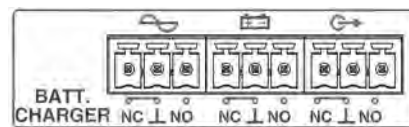

Picture 7: Monitoring inputs for the back-up power supply.

The connection is made through a female 9 pin euroblock connector and 3.81 mm pitch (supplied with the unit). The wire size range for each pole of this connector is: 0.14 – 1.5 mm<sup>2</sup> (30 – 14 AWG).

Marking	Description	Type	Signals	Activation
	Failure in the main power supply.	Input	NC ⊥ NO	Contact closure free of voltage between ⊥ NO and Open contact closure free of voltage between ⊥ NC
	Battery failure	Input	NC ⊥ NO	Contact closure free of voltage between ⊥ NO and Open contact closure free of voltage between ⊥ NC
	Failure in the emergency power supply output.	Input	NC ⊥ NO	Contact closure free of voltage between ⊥ NO and Open contact closure free of voltage between ⊥ NC

Table 1: Emergency Source Monitor Inputs

NOTE: Some EN 54-4 battery chargers have the same monitoring interface but with the inverse meaning of the NC and NO. It is recommended to revise the operating instructions in the user's manual. E.g. The model SONAES requires to invert the NC and NO connections.

### 2.4.2 EMERGENCY ACTIVATION INTERFACE

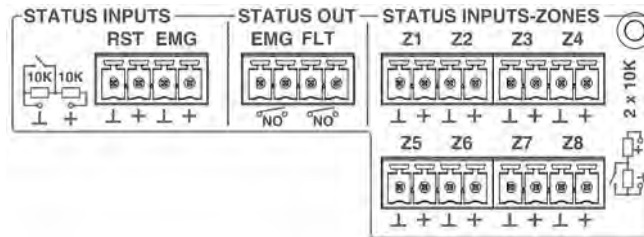

Picture 8: Emergency Activation Interface

The emergency activation interface is indicated to perform an interconnection with a fire control and indication equipment (CIE). All input connections are supervised in order to detect fault in the transmission line. This interface has three sections:

#### (a) GENERAL EMERGENCY MODE ACTIVATION INPUT

It allows activation and deactivation of the emergency mode of the entire system. It consists of two supervised inputs for the connection of voltage-free contact closures: Reset and Emergency. In order to have the link monitored, the contact closure connections to the equipment shall be done by two 10k external electrical resistances (supplied with the unit), placed at the output of the CIE as shown in the Picture 9.

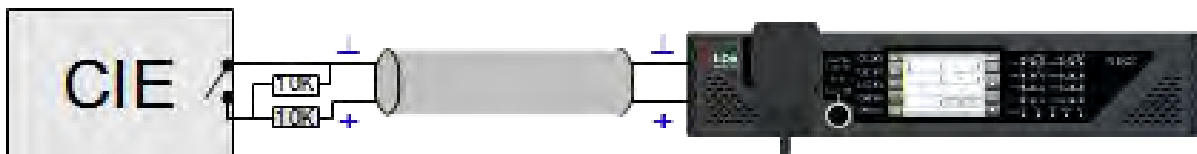

Picture 9: Supervised connection with the CIE

When the emergency input (EMG) is on, the machine will automatically switch from PA mode, to a state of emergency, and it will broadcast the voice evacuation message at all zones of the system (default option). The default evacuation sequence can be configured through the configuration software. When the reset input (RST) is enabled, the system will exit the emergency mode and return to the normal state.

If an error occurs in the transmission line between the CIE and the equipment, it will produce a fault indication in the front panel. (see 2.1.3). In systems in which these inputs are not used, connection monitoring must be disabled in the configuration software.

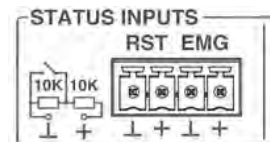

Picture 10: General Emergency Activation Input

**NOTE:** For avoiding an unwanted activation, the system does not allow that the activation inputs perform the sequence EMG, RST, EMG instantly. The second consecutive activation will leave a time lapse of 5 seconds.

The connection is via a 4-pin female euroblock connector of 3.81 mm pitch (supplied with the unit). The wire size range for each pole of this connector is: 0.14 1.5 mm<sup>2</sup> (30 14 AWG).

Marking	Description	Type	Signals	Activation
<b>RST</b>	Input for Reset of the Emergency State	Input	⊥ +	Voltage-free contact closure between ⊥ + Supervised input (see Picture 9)
<b>EMG</b>	Emergency State activation input	Input	⊥ +	Voltage-free contact closure between ⊥ + Supervised input (see Picture 9)

Table 2: General Emergency Inputs



### (b) SUPERVISED STATUS OUTPUTS

The equipment has two output signals, which indicate the operating state of the system. The EMG signal indicates that the system is operating in emergency mode. FLT signal indicates that the system is in failure mode. They consist of two voltage-free contact closure outputs normally open (NO).

The connection is via a 4-pin female euroblock connector and 3.81 mm pitch (supplied with the unit). The wire size range for each pole of this connector is: 0.14 1.5 mm<sup>2</sup> (30 14 AWG).

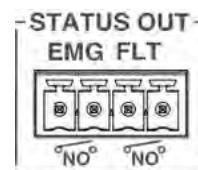

Picture 11: System Status Outputs.

Marking	Description	Type	Signals	Activation
<b>EMG</b>	Active Emergency State Output	Output	Close	Voltage-free contact closure between terminals (max 350mA / 350V dc)
<b>FLT</b>	Active Failure State Output Active Disarmed State Output	Output	Close	Voltage-free contact closure between terminals (max 350mA / 350V dc) Fault: intermittent Disarmed: Continuous

Table 3: System status outputs

### (c) EMERGENCY-ZONE ACTIVATION INPUT

It allows the configuration of eight sequences of evacuation defined by the user. By default, each emergency activation input will activate the emergency in one zone. It has eight supervised free voltage contact closure inputs. In order to have the link monitored, the contact closure connections to the equipment shall be done by two 10k external electrical resistances (supplied with the unit), placed at the output of the CIE as shown in Picture 9.

The manual activation has a higher priority over the external activation inputs, hence the emergency state can be stopped manually. The manual activation can not be stopped from a remote input.

The connection is via two 8-pin female euroblock connector of 3.81 mm pitch (supplied with the unit). The wire size range for each pole of this connector is: 0.14 1.5 mm<sup>2</sup> (30 14 AWG).

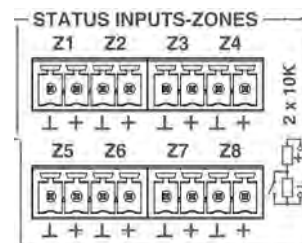

Picture 12: Emergency-Zone activation inputs

Marking	Description	Type	Signals	Activation
<b>Zx</b>	Activation of the Emergency State Input in the Zone X	Input	$\perp +$	Voltage-free contact closure between $\perp +$ Supervised Input (see Picture 9)

Table 4: Emergency-zone activation inputs

## 2.4.3 SPEAKER LINE DEVICES INTERFACE

### a) ATTENUATORS OVERRIDE OUTPUT

The equipment has 8 outputs for overriding attenuators in the PA line. At rest state they have 0V voltage. At active state, each output, has a voltage of 24V dc (\*) and 40mA of maximum electrical current. Each output has 2 poles.

The connection is via two 8-pin female euroblock connector of 3.81 mm pitch (supplied with the unit). The wire size range for each pole of this connector is: 0.14 1.5 mm<sup>2</sup> (30 14 AWG).

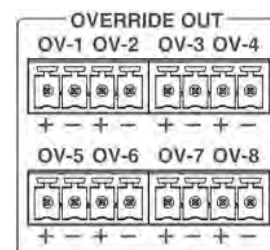

Picture 13: Attenuators override outputs.

Marking	Description	Type	Signals	Activation
OV-x	Attenuation of attenuators output	Output	+ -	24V dc 40mA

Table 5: Attenuators override outputs

NOTE: The average consumption of the attenuator override signal is 10mA per unit.

(\*): The output voltage could vary between 20 and 27V depending on the state of the battery.

#### (b) END OF LINE INPUTS

The equipment has 8 dual inputs for connecting end-of-line devices. Each input has 3 terminals, one common and two terminals for lines A and B, associated with the same amplifier channel (CH-x). When the activation signal occurs at one of the inputs, a loudspeaker line failure will be detected.

The connection is via 8-pin female euroblock connector with 3 contact of 3.81 mm pitch (supplied with the unit). The wire size range for each pole of this connector is: 0.14 1.5 mm<sup>2</sup> (30 14 AWG).

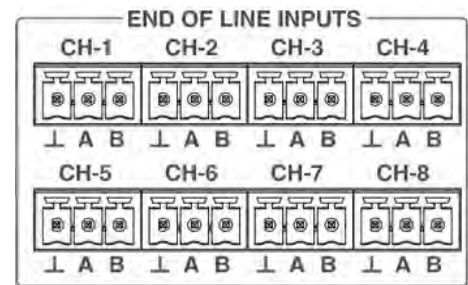

Picture 14: EOL device inputs

Marking	Description	Type	sSignal	Activation
CH-x	End-of-line device input	Input	⊥ A B	Voltage-free contact closure ⊥ A Voltage-free contact closure ⊥ B

Table 6: EOL device inputs

### 2.4.4 EXTERNAL SYSTEMS SLOT INTERFACE

The equipment has a slot where the ETX-1 module can be integrated. This module allows connection to NEO-Extension units, the control, monitoring and configuration through the data network, the reception of audio sources from the data network and the integration with third-party systems. The ETX-1 module is delivered as part of the equipment.

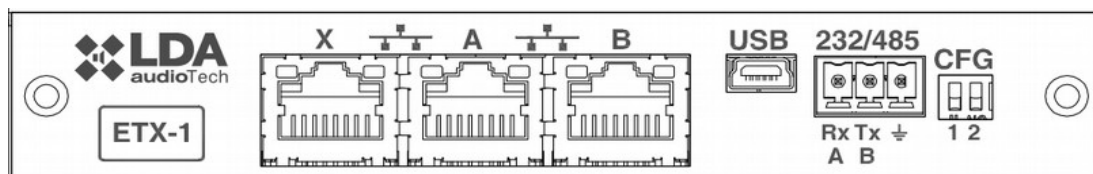

Picture 15: External Systems Slot Interface

#### (a) SYSTEM CONNECTION PORT X

The X port allows the connection of an external Ethernet network that can be used for control, monitoring and configuration and the reception of audio over the data network. It is possible to configure this port to be disabled during emergency mode, therefore enhancing the security in the internal network.

#### (b) SYSTEM CONNECTION PORTS A AND B

The equipment has two ports for the connection with other systems and NEO-Extension units. The behavior of this ports can be configured by a dip-switch as indicated in section (e). The default mode will be position 01, where A will be the main Flexnet connection and B the redundant Flexnet connection. In case of failure in port A, the system will automatically switch to port B.

The connection is made using standard CAT 5 Ethernet network cable RJ-45 T568B (the connection cable is supplied with the equipment).

Marking	Description	Type	Signals	Activation
<b>X/AB</b>	Ports for system connection	Port	Ethernet CAT5	Flexnet (propriety protocol) UDP Cobranet

Table 7: System connection ports

**(c) USB PORT (reserved)**

The USB port (mini USB type AB) integrated in the equipment is reserved.



Picture 16: USB Port

**(d) INTEGRATION SERIAL PORT**

The equipment has a two-wire RS-485 serial port. The default configuration for events for integration with third party systems is: 19200bps, 8 bits, even parity bit, 1 stop bit. The commands admitted in this port can trigger events in the system that can be configured through the configuration application.

NOTE: If configured for use of LDA VCC units, this port could not be used for other devices.



Picture 17: Integration Serial Port

The connection is made using a 3-pin female euroblock connector and pitch 3.81 mm (supplied with the unit). The wire size range for each pole of this connector is: 0.14 – 1.5 mm<sup>2</sup> (30 – 14 AWG). It is recommended to use twisted pair cabling for the connection of serial signals.

Marking	Description	Type	Signals	Activation
<b>485-AB</b>	Terminal A and B, Serial connection port for RS-485 integration	Port	<b>AB</b>	Standard RS-485/9600/8/N/1 see configuration software.
<b>485</b> ⊥	Cable net drape	NA	NA	NA

Table 7: Integration serial port

NOTE: The 232 marking corresponds to a reserved future use.

**(e) SYSTEM CONNECTION CONFIGURATION SWITCH**

The equipment has a dip-switch for configuring the behavior of the system connection ports. Depending on the position according to the following table







Marking	Description	Type	Signals	Activation	
<b>CFG</b>	Port A : Control data exclusively Puert B : Audio data exclusively Puert X : Flexnet**	Config.	NA	Posición 00	
<b>CFG</b>	Puert A : Flexnet** Puert B : Flexnet** Puert X : Control data exclusively	Config.	NA	Posición 01	
<b>CFG</b>	Puert A : Flexnet** Puert B : Flexnet** Puert X : Audio data exclusively	Config.	NA	Posición 10	
<b>CFG</b>	Puert A : Flexnet** Puert B : Flexnet** Puert X : Flexnet**	Config.	NA	Posición 11	

Table 8: System connection configuration

\*NOTE 1: in NEO 8060, port B will be normally inactive in modes 01,10 and 11 for avoiding the storm effect in the Flexnet network ring. It will only operate when detecting a disconnection of a NEO-Extension unit in the bus.

\*\*NOTE 2: Flexnet mode will have Control Data in VLAN1 + Audio Data in VLAN2. For more information about Flexnet, see chapter 4.3.

### 2.4.5 POWER SUPPLY

Every equipment in the NEO series has double redundant power supply.

#### (a) AC LINE VOLTAGE SELECTOR

The equipment has an AC line voltage selector 230V / 115V, by default in the 230V position. Check the local line voltage to configure the selector.



Picture 18: AC Line voltage selector

Marking	Description	Type	Signals	Activation
	AC line voltage selector	Config	<b>NA</b>	230V /115V

Table 9: Line Voltage Selector

#### (b) MAIN POWER SUPPLY INPUT

The unit has an IEC 60320/C14 input connector for connection to the main power supply.

The connection is made using IEC power cord to E + F Male 60320/C13 plug supplied with the equipment.

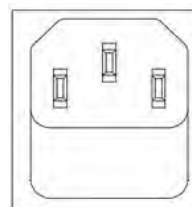

Picture 19: Main power supply input

Marking	Description	Type	Signals	Activation
	Main power supply input	Input	<b>L N G</b>	230V /115V ! 50/60Hz (according to selector)

Table 10: Main Power Supply Input

#### (c) EMERGENCY POWER SUPPLY FUSE:

The unit has room for a fuse to protect the overload of the emergency power supply input. The fuse will be cylindrical with a 6x32mm glass, and the maximum intensity specified in the technical specifications of the equipment (see section 7 ). To access the fuse, turn the fuse-holder a quarter turn counter-clockwise using a flat blade screwdriver.



Picture 20: Emergency Power Supply Fuse.

#### (d) EMERGENCY POWER SUPPLY INPUT:

The unit has an input for emergency power supply. The emergency power is continuous and 24V nominal value. It will be supplied independently, consisting of a battery system and charger according to EN54-4. The input consists of a two-pole + and - connector to be connected to the positive and negative poles of the battery system. For more information about the connection of the emergency power supply system, see section 4.1

The connection is made by 2 pin female euroblock connector and 7,62 mm (supplied with the unit). The wire size range for each pole of this connector is 0.2 6mm<sup>2</sup> (24 8 AWG).

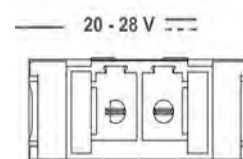

Picture 21: Emergency Power Supply Input

Marking	Description	Type	Signals	Activation
<b>20-28V</b>	Emergency Power Supply Input	Input	<b>+ -</b>	20 - 28V DC Maximum Power: see technical data (Chapter 7)

Table 11: Emergency Supply Input

## 2.4.6 SPEAKERS LINES

### (a) SPARE CHANNELS INPUT

The equipment has 8 inputs back-up amplifier channels per each internal amplifier. Each connection has two terminals + and – where the redundant amplifier output will be connected. The redundant amplifier must be a 100V line public address amplifier with a minimum power equal to the nominal channel amplification power of the equipment. For more information about the connection of back-up amplifier, see chapter 4.5 .

The connection is made with a 2-pin female euroblock connector and pitch 5.08 mm (supplied with the unit). The wire size range for each pole of this connector is: 0.5 – 2.5 mm<sup>2</sup> (22 – 12 AWG).

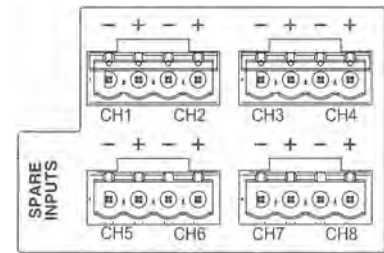

Picture 22: Back up amplifiers inputs

Marking	Description	Type	Signal	Activation
<b>SPARE CH INPUTS X</b>	Input amplification channel corresponding to the channel reservation amplification equipment X	Input	+ -	NA

Table 12: Spare Channel Inputs

### (b) SPEAKER LINE OUTPUT

The equipment has between 4 and 8 amplification channels, each channel has two speaker line outputs marked as A and B. The rated power of the amplifier channel is divided between both output lines. For more information about the connection of the speaker lines see chapter 4.4 . Each line connection has two + and - terminals for connecting speakers to 100V or low-impedance depending on the model.

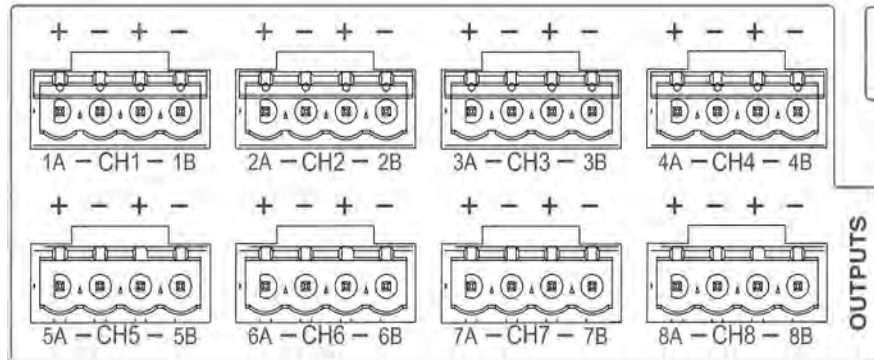

Picture 23: Speaker Lines Outputs

The connection is made by euroblock female connector and 2-pin pitch 5.08 mm (supplied with the unit). The wire size range for each pole of this connector is: 0,5 – 2,5 mm<sup>2</sup> (22 – 12 AWG).

Marking	Description	Type	Signals	Activation
<b>CHX XA XB</b>	CHX Amplification channel X. XA Speakers line A of amplification channel X. XB Speakers line B of amplification channel X.	Output	+ -	NA

Table 13: Speaker Lines Outputs

## 2.4.7 INPUTS AND OUTPUTS OF AUDIO SOURCES

### a) RECORD OUPUT

The equipment has a line level balanced audio output, which includes a switching signal active at low level (TTL). It allows monitoring and recording the messages sent from the emergency microphone. When at one or more voice evacuation zones, a warning is issued by live voice (microphone), the recording output will be activated, reproducing the emission signal at the zone or voice evacuation zones. In that case, the output operation is activated at a low level.

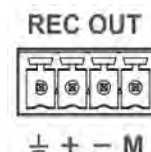

Picture 24:  
REC output

The connection is made by euroblock female connector and 4-pin 3.81 mm pitch (supplied with the unit). The wire size range for each pole of this connector is: 0.14 1.5 mm<sup>2</sup> (30 14 AWG).

Marking	Description	Type	Signals	Activation
<b>REC OUT</b>	Balanced Audio at line level	Ouput	⊥ + -	Message from emergency microphone broadcasted by any zone through voice evacuation
<b>REC OUT</b>	Recording output activation	Ouput	⊥ M	0V DC

Table 14: REC Output

### (b) PRIORITY INPUT (PRIO INPUT)

NEO-Extension models have a PRIO Input instead of a REC Output. This priority input for PA mode, it is activated through a contact closure in pin "M", when active, the PA led light will blink. The audio of this input will be routed to every output while the activation signal is active, unless the system enters into Emergency mode, in that case, the emergency inputs will have priority and the routing will be assigned according to the evacuation.

### (c) PAGING MICROPHONES AND SYSTEM DEVICES INPUT (ACSI BUS)

The NEO 8060 has an special input for microphones where MPS-8Z and VAP-1 units are connected. It is an input that combines line-level audio, control signals and power supply for up to 8 devices in bus mode. This line uses input number 5 of the available audio inputs, therefore when it is been used, input number 5 will be occupied. For more information about the connection of this input, see chapter 4.2 .

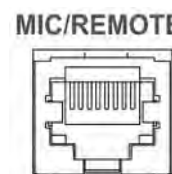

Picture 25:  
ACSI Bus  
Input

The connection is made via Ethernet cable, T568B standard. Maximum connection distance for the entire bus is 1000m (914,4 yrd).

Marking	Description	Types	Signals	Activation
<b>MIC/ REMOTE</b>	Balanced Audio at line level	Input	Protocol	NA

Table 15: ACSI bus Input

NOTE: This connection is not compatible with the Ethernet standard.

### (d) AUDIO LINE LEVEL OUTPUT

The equipment has 8 balanced audio line level outputs, one per amplification channel. The audio signal will be the same routed at each amplifier.

The connection is made using 8 female connectors euroblock type of 3 contacts and pitch 3.81 mm (supplied with the unit). The wire size range for each pole of this connector is: 0.14 1.5 mm<sup>2</sup> (30 14 AWG).

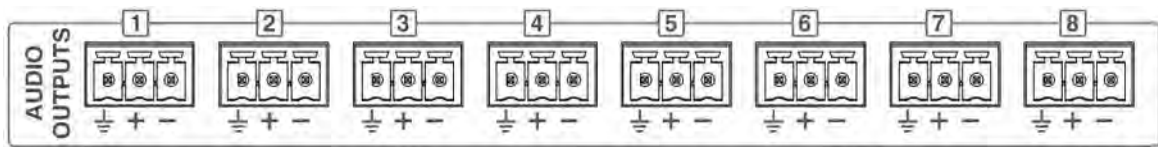

Picture 26: Pre-amp outputs

Marking	Description	Types	Signals	Activation
<b>AUDIO OUTPUTS X</b>	Balanced audio line level output replicant of the signal of the integrated amplifiers	Output	⊥ + -	NA

Table 16: Pre-amp/Line-level outputs

**(e) AUDIO SOURCE INPUTS**

The NEO 8060 has 5 line-level balanced audio inputs. Input no.5 is shared with the Bus ACSI input. When the Bus ACSI is being used, input no.5 will be disabled. Above the inputs there is a level indicator led which turns green when the input signal exceeds-50dB, and red when exceeding-10dB.

The connection is made using eight female connectors euroblock type of 3 contacts and pitch 3.81 mm (supplied with the unit). The wire size range for each pole of this connector is: 0.14 1.5 mm (30 14 AWG).

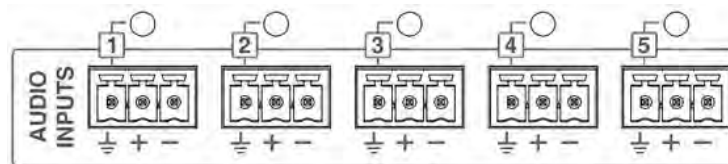

Picture 27: Audio Source Inputs

Marking	Description	Type	Signals	Activation
<b>AUDIO INPUTS X</b>	Balanced audio input to line level and signal level indicator	Input	⊥ + -	Green: Level over -50 dB Red: Level over -10 dB

Table 17: Audio Source Input

**(a) FUENTES DE AUDIO PA-LIVE**

The model NEO4500LE has audio inputs for use in PA-LIVE mode. This inputs will be activated through the configuration software and are dedicated to those cases where it is preferred not to control the audio input from the NEO system. In this case, audio inputs go directly to the amplifier outputs. The priority level can be configured. When the system is in emergency mode, it will take control of the outputs.

For example, in a theater or a stadium, it is possible to connect the mixing console to this inputs and use the NEO-4500LE for live pro-audio installations, with the advantage that in case of evacuation, it will always prioritize the emergency inputs of NEO. In this sense, the voice reinforcement system can also be used for evacuation.

**2.4.8 SYSTEM INTEGRATION PORTS**

**(a) GENERAL POURPOSE INPUTS/OUTPUTS (GPIO)**

The equipment has 14 GPIO ports for system events, programmable thought the configuration software. GPIO ports work with TTL-level logic signals (0 - 5V DC).

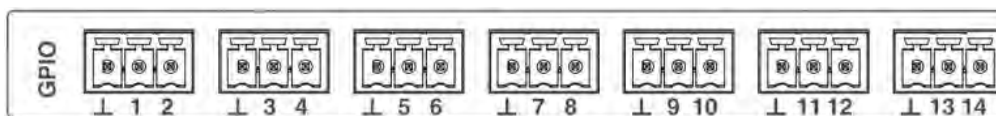

Picture 28: GPIO ports

The connection is made using 7 female connectors euroblock type with 3 contacts and pitch 3.81 mm (supplied with the unit). The wire size range for each pole of this connector is: 0.14 1.5 mm<sup>2</sup> (30 14 AWG).

Marking	Description	Type	Signal s	Activation
<b>GPIO X</b>	Port General Purpose I / O configurable	Input/ Output	<b>⊥ X</b>	Output 0-5V DC Input 0-5V DC

Table 18: GPIO ports

#### (b) PORT FOR ADVANCED INTEGRATION WITH THE CIE

The equipment has a supervised serial communications port, RS-485, for connection to the central fire detection system / Control and Indicating Equipment (CIE). To select a compatible system that will connect the equipment you should use the configuration software.

The connection is via a female connector euroblock type of 3 contacts and pitch 3.81 mm (supplied with the unit). The wire size range for each pole of this connector is: 0.14 1.5 mm<sup>2</sup> (30 14 AWG).

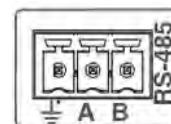
 Picture 29:  
Bus RS-485  
for CIE

Marking	Description	Type	Signals	Activation
<b>485-AB</b>	Port serial connection for integration RS485 Terminal A and B	Port	<b>AB</b>	standard RS-485/9600/8/N/1 see configuration application
<b>485 ⊥</b>	Chassis or wire mesh	NA	NA	NA

Table 19: CIE Advanced Port Integration through RS-485



## 3 FUNCTIONING

### 3.1 SYSTEM BOOTING

Before connecting the equipment to the electricity network, check that the equipment's rated voltage selector, located at the rear, is in the position corresponding to the power supply voltage available in the region, see chapter 2.4.5 for more information. Connect the power cord to the CIE connector located on the rear panel. In the frontal panel of the equipment, the "POWER" indicator will light green.

When you turn on the equipment for the first time you should make the proper adjustments for the installation, see chapter 4.

### 3.2 EMERGENCY

#### 3.2.1 ACTIVATING THE EMERGENCY STATE

To perform an evacuation announcement, the system must be in a state of emergency. From this mode of operation the following types of signal may be issued:

- Recorded alert message: "PLAY ALERT MESSAGE"
- Recorded evacuation message: "PLAY EMG MESSAGE"
- Live message from the emergency microphone: "SELECT EMIC ZONES"

To activate the emergency state, proceed as follows:

Press the button "EMG" in the menu, select "EMERGENCY STATE". An access control will appear for level 2 users (see 2.3). Only authorized personnel, could continue operating the equipment. To return, press the "BACK" button. The level of access authorization will change to "level 2", and the state of emergency will be activated. When activated, it will go directly to the emergency source menu (see 3.2.2) If you want to stay in a state of emergency without performing any action, press the "BACK" button. The access level will remain at "level 2", and the state of emergency active. To exit the "Level 2" restart the state of emergency, according to 4.2.4, or do not take any action for the next 90 sec.

When the state of emergency is activated, an audible warning signal will be activated. This signal is automatically muted when using the emergency microphone, or manually, by pressing the "ACK" button.

#### 3.2.2 ACTIVATING THE VOICE ALARM

It is possible to broadcast pre-recorded messages and live announcements to different zones simultaneously. The priority of emergency sources from higher to lower level of importance is: Live message from emergency microphone, evacuation recorded message and alert recorded message. For example: If an evacuation message is routed to a zone with an alert message, the alert message will immediately cease.

Once in the Emergency state (3.2.1) it is possible to select the following options:

- a) "PLAY ALERT MESSAGE", for activation of the alert message or "PLAY EVAC MESSAGE", for activation of the evacuation message.

Click on the desired option and a selection band will appear in the button. Then select the zone or zones for which the message will be played, as indicated in section 2.2.7. After the selection of the zones, press "OK" to confirm and the message will begin to play. Pressing the button OK, without selecting any zone, is equal to selecting all available zones.

Led indicators of EVAC or ALERT will turn on when a message is being played in any zone.

**b) "SELECT EMIC ZONES" for activation of EMIC in the selected zones.**

Select the zones and press the PTT button in the EMG microphone to broadcast the announcement. The EMIC led will turn on indicating it is possible to start the live announcement. In case the ding-dong option was activated, the led will blink until the sound finishes. The zone selection will be activated until the selection is disabled or until the emergency state is reset.

In order to make a new selection, first the current selection must be cleared. The button "CLEAR EMIC ZONES" will be displayed. Once pressed, the "SELECT EMIC ZONES" option will appear again and a new selection can be made.

**c) "EMG SEQUENCES" for loading an emergency sequence or emergency event.**

This option allow the activation of pre-defined evacuation sequences. This menu will show the ID numbers of the VA events created in the configuration software. For activate/deactivate the event press the desired number and OK to confirm.

NOTE: The zone selection of an emergency pre-recorded message or live message will be cleared once a new selection is made.

### 3.2.3 STOPPING VOICE ALARM

To stop broadcasting an evacuation message, re-enter the " EMERGENCY STATE", as described in chapter 3.2.1, the active emergency source will show in a band of selection. Click on the available option to stop the message. The button will change to normal state, without band selection. For stopping the emergency microphone just release the PTT button.

You can also stop the broadcast by disabling the emergency state ( see 3.2.4)

### 3.2.4 DEACTIVATING THE EMERGENCY STATE

To disable the emergency state, press the " RESET" button, it will appear on the access control for users with level 2 (see 2.3). To return, press the " BACK" button. If you successfully complete the access control, the state of emergency will be disabled. All emergency warning broadcasts, will be stopped.

### 3.2.5 EMERGENCY STATE LOG

The system has a log that records the operations or indications made during the Emergency state. The emergency state log will be displayed on the screen automatically when the equipment / system is being remotely activated. It will show the log for one hour since the last entry occurred in the log. A whole year's log will be accessible through the configuration application .

Once the log has been checked, press the " ACK " button and the log will automatically stop being displayed. You can access the record again by pressing the button "EMERGENCY LOG" in the EMG state. A list of records will be showed in chronological order from newest to oldest operations and indications that have occurred. To exit the emergency state log, press the "BACK" button.

To view all issued logs, use the scroll control up and down to scroll the window. You can see an overview of all logs in Appendix B: Content of logs.

### 3.2.1 VOICE EVACUATION ZONE VOLUME ADJUSTMENT

The equipment/system has an independent adjustment of the volumes of voice evacuation zones. If this setting is not defined, the volume in this state, will be the same as configured in the paging mode (see 3.5.1).

To set the volume, adjust the volume through the configuration application or according to chapter 3.5.1. Once the setting has been made, use the configuration application to memorize it as the default volume for the emergency state.



### 3.3 FAILURE

#### 3.3.1 FAILURE STATE LOG

The system has a log of detected failures. This log will be automatically displayed on the screen when the equipment / system is in this state for five minutes since the last entry occurred in the log. A whole year's log will be accessible through the configuration application .

Once the log has been checked, press the " ACK " button and the log will stop displaying automatically. You can view it again by pressing the shortcut button to the fault state " FLT ", a list will show in chronological order from newest to oldest, the operations and indications that have occurred. To exit the emergency state log , press the "BACK" button.

To view all logs, use the scroll control to scroll up and down the window. You can see an overview of all logs in Appendix B: Content of logs.

#### 3.3.1 RESET FAILURE'S STATE

To reset the failure's state, press the " RESET" button, the display will show an user control access level 2 (see 2.3). To return, press the " BACK" button. If you successfully complete the control access, all faults will be reset.

### 3.4 DESARMING

The equipment / system provides features to disarm or disable voice alarm zones that will not be used. Once disabled, these will be displayed in the menus, as described in section 2.2.7 (e). It is not possible to perform any operation on a disabled zone. The information provided for the states of emergency or failure will not be displayed .

#### 3.4.1 DEACTIVATING/ ACTIVATING A ZONE

To access the deactivation menu, press the shortcut button "DIS". From the disabling menu press the " DISARMED STATE" option, the display will show an access control for level 2 users (see2.2.7). To return, press the " BACK" button. If you successfully complete the access control, all zones will be displayed, make the selection or deselection of the zones to disable/enable, and click " OK" to confirm.

When the deactivation occurs in a zone, the corresponding amplifier channels to that zone indicate the disarmed state in the led indicators. (see 2.1.2).

#### 3.4.2 DISARM LOG

The system has a log of disarmed zones, that displays the the operations that have been made during the last hour in the disarmed stated. A whole year's log will be accessible through the configuration application .

In order to view the log, press the button" DIS", and then "DISARMED LOG". A list will chronologically show the operations and indications that have been made. To exit the disarmed log, press the button "BACK".

To view all the log, use the scroll up and down button to move around the window. A description of all the logs will be available at Appendix B.

### 3.5 PA MODE

The equipment / system NEO, besides acting as a voice evacuation system, can function as a high-performance public address system, when a voice evacuation is not required.

To access the Paging menu, proceed as follows:

Press the shortcut button "PA", the access control for users with level 2 will appear (see 2.3). To return, press the "BACK" button. Once passed the access control, the level of access authorization, will change to "Level 2" and access the menu, which contains the options: Zone volume setting, routing of audio sources and advanced.



Picture 30: PA Menu Window

### 3.5.1 ZONE VOLUME SETTING

The equipment/ system, allows adjustment of volumes for each zone. This setting can be independent from the zone volume adjustment made to broadcast the voice message in emergency state, if it has been previously configured (see 3.2.1). The adjustment of the zones is relative to the adjustment of the output gain or audio outputs grouped in the zone (see 3.5.5).

To make this setting, from the PA menu window, click on the zone volume setting button "ZONES VOLUME", the following window will appear:

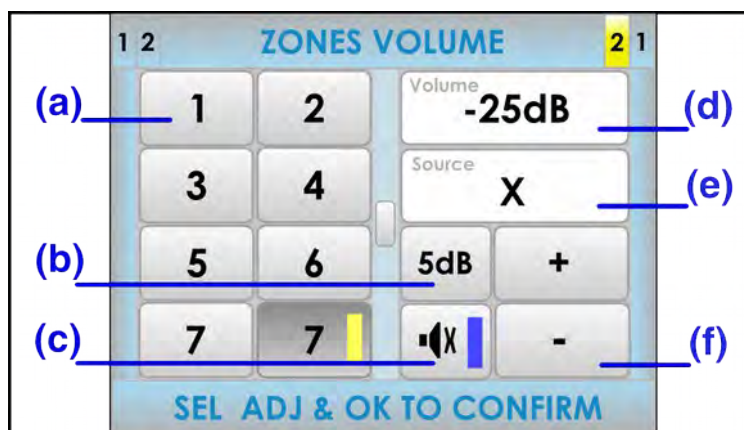

Picture 31: Zones volume setting Window

#### (a) ZONES BUTTONS

In the left half of the screen, the zones can be found. Press on the zones in which you want to set the volume. If the progress indicator appears (see 2.2.6) use the scroll control to display the other zones. If there is no selection, the setting is made on all zones of the system.

#### (b) GAIN STEP SETTING BUTTON

The step setting button, allows the selection of the step increment / decrement to be performed when you press on the volume adjustment buttons. You can select from the following values, pressing consecutively: 1dB , 5dB , 10dB.

#### (c) MUTE BUTTON

The mute button allows a radical decrease of the volume of the zone / zones to a minimum. When the mute is disabled, the zones will recover the volume they had before being silenced. If you turn the mute button on a zone / zones which was not selected , there will be no setting on it.

**(d) VOLUME INDICATOR**

The volume indicator goes from -100dB to 0dB, minimum and maximum respectively zone volume. If a zone is selected, the current volume level will be displayed, and will be updated while you make the settings. If you have made a multiple selection, any value will be shown, until a setting is made. In this case, only the setting made will be display.

**(e) ROUTED SOURCE**

This field will show the audio source routed to the selected zone.

**(f) VOLUME ADJUSTMENT BUTTONS**

The volume adjustment window has two buttons to adjust " + " and " - ", each time you press one of them, it will be increased or decreased, as many decibels as the " Gain Step Setting" is displaying. To carry out this setting, select the zone/zones on which you would like to perform the adjustment, change the value of the volume, and confirm by pressing " OK".

To cancel, press the " BACK" button. If there is no selection of zone/zones, the settings will be applied to all zones.

NOTE: If you make a multiple selection of zones, it is possible to apply a relative increase or decrease in volume. The maximum value that can reach the group is determined by the zone, within the selected group, which has a the highest volume. So when it reaches the 0dB (maximum), or the set step is greater than the difference between 0dB and the current value will not be allowed to continue to increase the volume. The same happens in the case of the minimum volume.

**3.5.2 ROUTE SOURCES**

To route any available audio source to any of the zones or group of zones, press the button "ROUTE SOURCES". The following window will appear:

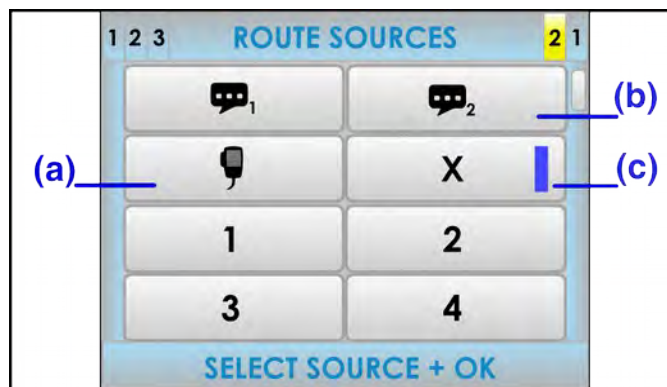

Picture 32: Route sources Window

**(a) EMERGENCY MICROPHONE**

On special occasions, you can use the emergency microphone to make announcements by one or more zones in PA mode. Once the audio source routing is concluded, use the PTT button on the microphone to make the announcement.

**(b) PRE-RECORDED MESSAGES**

From this menu you can select one of the two pre-recorded message player sources integrated in the equipment. To play the message, once the routing a message player is done, you must access the pre-recorded message window in the advanced menu (see 3.5.1) and play the selected message.

**(c) SELECTION INDICATOR**

When the audio source has been selected, a blue band selection within the source button will appear.

**(d) DEROUTE AUDIO SOURCE**

To clear the current assignment of an audio source to a zone / zones, select the source marked as an "X". A new routing is done automatically if you assign a new source to a zone that previously had an audio source routed.

Once you have done the source selection, if you want to cancel, press the "BACK" button. To confirm the selection, press the "OK" button, you will access to the zone selection menu where you can assign the zones to be assigned sound source (see 2.2.7).

NOTE: When the ACSI bus is being used (see 4.2), the audio source number 5 will change into a microphone icon. This source will also be shown as unavailable.

NOTE: When the zone selection is for one of the pre-recorded message players or the EMIC, the selection will be cleared when performing a new selection. When the selection is for any of the other audio sources, the selection will be cumulative, meaning the zones not affected by the selection will keep its audio routing.

**3.5.3 AVANCED OPTIONS**

The equipment/system has advanced adjustment options. To access these options, from the PA menu, click on the "ADVANCED" button, an user control access level 3 (see 2.3). will be displayed. To return, press the "BACK" button. Overcome the access control, the level of access authorization, will change to "Level 3" and access the menu, which contains the options:



Picture 33: Advanced Options Menu

**(a) AUDIO INPUT**

Access window settings for the audio inputs. For more detail see 3.5.4

**(b) AUDIO OUTPUT**

Access settings window for audio outputs. For more detail see 3.5.5

**(c) MONITOR**

The equipment/system, has an integrated speaker that lets you hear the audio sources that are available, and the audio input routed to each zone. For more detail see 3.5.6

**(d) MESSAGES**

Access to the pre-recorded messages menu.

**(e) LOAD PRESET**

Access to the selection window of saved memory with a certain system operation (preset). To configure and save the preset you must use the configuration software.

**(f) SYSTEM**

Access to the system's information window and identification configuration.

### 3.5.4 AVANCED OPTIONS. AUDIO INPUT.



Picture 34: Audio Input Setting Window

#### (a) AUDIO INPUT SELECTION BUTTONS

The audio inputs are in the left half of the screen. Click on the desired entry and if the progress indicator appears (see 2.2.6), use the scroll control to display the rest of available audio inputs.

#### (b) "LDA SOUND ENHANCEMENT" BUTTON

Click to activate the LDA sound enhancement. LDA sound enhancement, processes the input signal in digital mode to achieve optimal levels for broadcast, thus eliminating loss of intelligibility due to clipping distortion, or due to low input signal levels.

#### (c) VUMETER INDICATOR

Displays the signal level detected at the input. Between -100dB and 0dB.

#### (d) EQUALIZER BUTTON

Press to activate the equalizer memory configured using the configuration software.

#### (e) GAIN INDICATOR

Displays the set gain for the selected audio source.

#### (f) GAIN STEP SETTING BUTTON

The gain step setting button, allows the selection of the amount of increment/decrement to be performed in the audio source when you press on the volume adjustment buttons. You can select from the following options, pressing consecutively: 1dB, 5dB, 10dB.

#### (g) VOLUME ADJUSTMENT BUTTONS

The window has two buttons to adjust gain, "+" and "-", each time you press one of them, it will be increased or decreased, as many decibels as the "gain step setting button" is displaying.

#### (h) MUTE BUTTON

The mute button allows a radical decrease of the volume of the input to a minimum. When the mute is disabled, the input will recover the volume it had before being silenced.



### 3.5.5 AVANCED OPTIONS. AUDIO OUTPUT.



Picture 35: Audio Output Setting Window

#### (a) AUDIO OUTPUT SELECTION BUTTONS

In the left half of the screen, there are the audio outputs (output channel for amplifier). Click on the desired output. If the progress indicator appears (see 2.2.6), use the scroll control to display the rest of outputs available.

#### (b) LOUDNESS BUTTON

Press to turn on loudness compensation. Loudness compensation introduces dynamic equalization which is applied depending on the gain applied to the output channel. If the gain is at maximum, it has no effect. If the level is different from the maximum, a compensation will be introduced in the bass and treble levels so that you get an excellent perception of the sound being played.

#### (c) VUMETER INDICATOR

Displays the signal level that is being detected in the output. Between -100dB to 0dB.

#### (d) EQUALIZER BUTTON

Press to activate the equalizer memory configured using the configuration application.

#### (e) GAIN INDICATOR

Displays the gain setting for the output selected on the volume of the zone.

#### (f) GAIN STEP SETTING BUTTON

The gain step setting button, allows the selection of the amount of increment/decrement to be performed in the audio output when you press on the volume adjustment buttons. You can select from the following options, pressing consecutively : 1dB , 5dB , 10dB.

#### (g) VOLUME ADJUSTMENT BUTTONS

There are two buttons to adjust " + " and " - " the gain or volume. Each time you press one of them, it will be increased or decreased , as many decibels as the " Gain Step Setting " is displaying. This adjustment is relative to the volume of the zone, therefore, if several output channels are grouped in a zone, it will be possible to adjust as many dB as the volume of the zone of the selected channel. To carry out this setting, select the output on which you would like to perform the adjustment, change the value of the volume, and confirm by pressing " OK ".

To cancel, press the " BACK " button. When the gain to be applied to the output will reach its top or bottom limit (0dB or -100db), it will be blocked. As a result, an output with a theoretical gain of -5dB that belongs to a zone with the volume adjusted to -10dB, it will display an effective gain of -15dB. When increasing the output gain, it will get blocked when reaching the value -10dB, that corresponds to 0dB of output gain (maximum value).

#### (h) MUTE BUTTON

The mute button allows a radical decrease of the volume of the output to a minimum. When the mute is disabled, the output will recover the volume it had before being silenced.

### 3.5.6 AVANCED OPTIONS. MONITOR

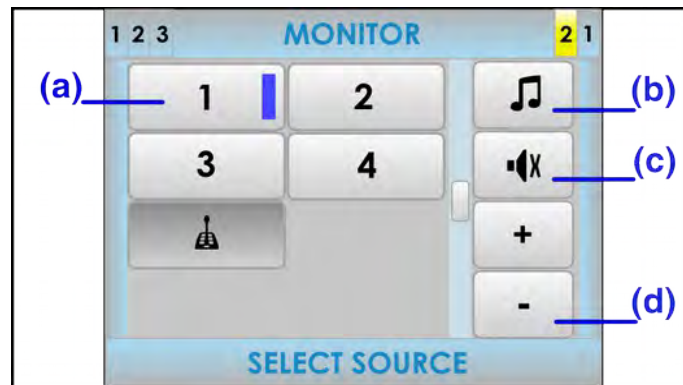





Picture 36: Monitor Window

#### (a) SELECTION BUTTONS

On the left side of the screen there are buttons for selecting the element to be monitored. Click on the desired item. If the progress indicator is shown (see 2.2.6) use the scroll control to display the rest of elements available.

#### (b) TYPE OF MONITORING BUTTON

The type of monitoring button, allows to select what kind of elements are to be monitored. Press until you find the desired item type:

-  Music source
-  Zone
-  Pre-recorded message player 1 or 2
-  Emergency microphone

#### (c) MUTE BUTTON

The mute button allows a radical decrease of the volume of the input to a minimum. When the mute is disabled, the input will recover the volume it had before being silenced.

#### (d) VOLUME ADJUSTMENT BUTTONS

The window has two buttons to adjust volume "+" and "-", each time you press one of them, the volume of the monitor speaker will be increased or decreased by 1 dB.

To monitor, select the type of item using the "type of monitoring" button, and then click the item to be monitored. Adjust the monitor's volume. To finish, press the "BACK" button.

NOTE: If the music source input 5 is being used by an ACSI element such as a MPS-8Z microphone, this will also be monitored when one of the microphones are paging to any of the zones of the system.

NOTE: In case the type of item to monitor is a pre-recorded message, press the desired player to directly access the messages window (see 4.5.1). From this windows it is possible to start or stop the playback of the desired message. From the message player window, press the "BACK" button to return to the monitor window.

### 3.5.1 AVANCED OPTIONS. MESSAGES.

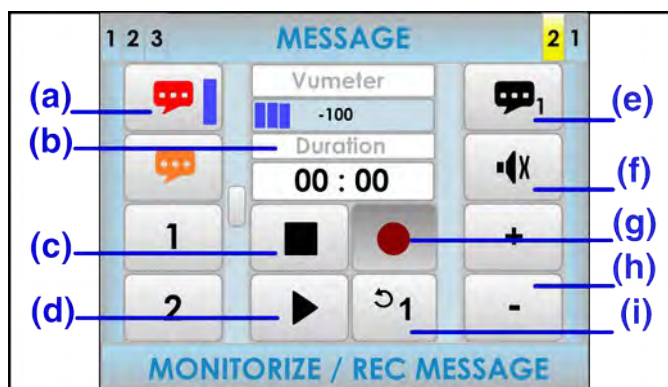

Picture 37: Message Window

#### (a) MESSAGE LIST

In the left column of the screen, you can find the list of pre-recorded messages. If the progress indicator is present (see 2.2.6), use the scroll control to display the remaining messages available. To select one, press its corresponding button in the list and a selection band will appear in the button.

#### (b) MESSAGE DURATION INDICATOR

Displays the message duration in minutes and seconds when the message is selected. When the message is playing, it will display a countdown of duration equal to the duration of the message.

#### (c) STOP BUTTON

The stop button allows to stop the playback completely. The duration indicator shows the length of the selected message. Once the action has stopped, both the playback or recording should be started from the beginning of the message. A selection band will appear when the message is stopped.

#### (d) PLAY/PAUSE BUTTON

This button starts the playback of the message. When the message is being played, it will pause the playback of the message.

#### (e) MESSAGE PLAYER SELECTOR

Selects the message player to use. The system has 2 pre-recorded message players.

#### (f) MUTE BUTTON

The mute button allows a radical decrease of the volume of the input to a minimum. When the mute is disabled, the input will recover the volume it had before being silenced.

#### (g) REC BUTTON

The rec button starts the recording over the selected pre-recorded message.

NOTE: If this button is in gray colour, the system does not allow this function or it is not implemented.

#### (h) VOLUME ADJUSTMENT BUTTONS

The window has two buttons to adjust volume "+" and "-", each time you press one of them, the volume of the monitor speaker will be increased or decreased by 1 dB.

#### (i) LOOP BUTTON

Allows an automatic repetition of the message. It is possible to select either 1, 2 or 3 repetitions of the message or loop mode for an indefinitely number of repetitions.

NOTE: if the message players requires the use of the pre-recorded message player will clear this command.

### USE OF THE PRE-RECORDE MESSAGE PLAYER



To play a message, first select it in the left side column list and then press the play button. To pause or stop the playback, press the pause or stop buttons. If you would like to hear from the speaker monitor the selected message being played, use the monitor controls placed in the right side of the screen.

### 3.5.1 ADVANCED OPTIONS. LOAD PRESET

The system allows the use of presets that will instantly modify the parameters of audio regarding volume, routing, etc. It is possible to create and save new presets in the equipment from the configuration software. With the use of presets, habitual system's audio adjustments can be applied very quickly.

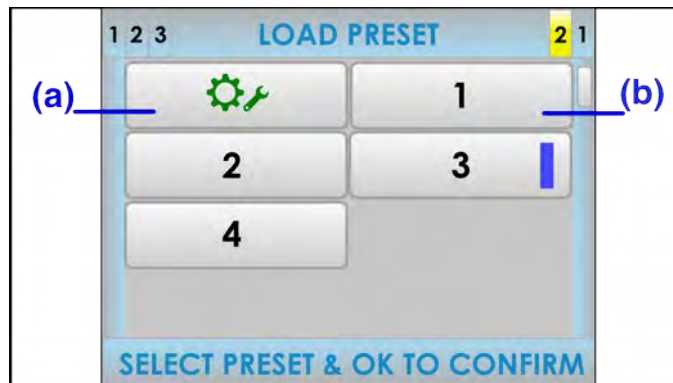

Picture 38: Load Preset Window

#### (a) FACTORY PRESET BUTTON

The factory preset button will load the default audio configuration of the equipment. All the audio configuration that was configured by the user will be replaced.

#### (b) BOTONES DE PRESET

Press over the preset button that you want to load. If the progress indicator is present (see 2.2.6) use the scroll control to display the remaining presets available. To confirm press the button "OK".

NOTE: It is possible to create or modify presets from the configuration software.

### 3.5.2 ADVANCED OPTIONS. SYSTEM

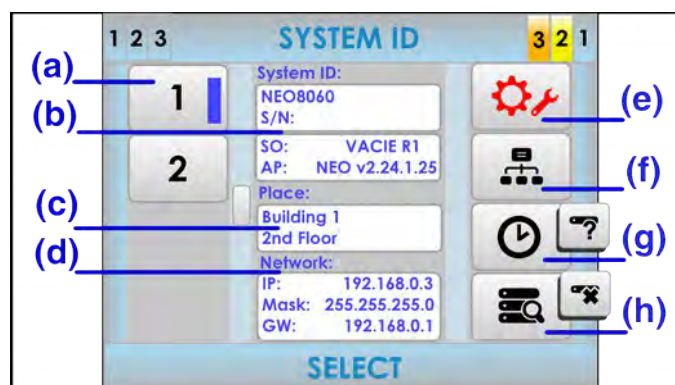

Picture 39: System's Advanced Options Window

#### (a) SYSTEM'S EQUIPMENT LIST BUTTONS

The left side of the windows will show the current equipment present in the system. If the progress indicator is present (see 2.2.6) use the scroll control to display the remaining equipment units available. Select the desired button in the list of items to show its information. A selection band will appear in the selected item.

**(b) SYSTEM IDENTIFIER**

In this section, you will find information of the equipment related to the system. First, there is the name or identifier of the equipment, followed by the serial number associated with it. Below, you will see the version of the equipment's operating system, followed by the version of the application firmware installed. To upgrade the firmware, you must use the configuration software.

**(c) LOCATION IDENTIFIER**

This area shows the information of the physical location of the equipment, previously introduced in the configuration software.

**d ) CURRENT NETWORK SETTINGS**

Shows the current network configuration of the equipment.

**e ) FACTORY RESET**

**ATTENTION:** This button can perform a factory reset of the equipment. When pressed it will indicate that all settings will be reset to default and you can Confirm or Abort.

#### f ) NETWORK CONFIGURATION BUTTON

The network configuration button, enters into the equipment's network configuration menu.

NOTE: You must press the **OK** button present in the numbers keyboard, as shown in the following picture, to save changes in the configuration.

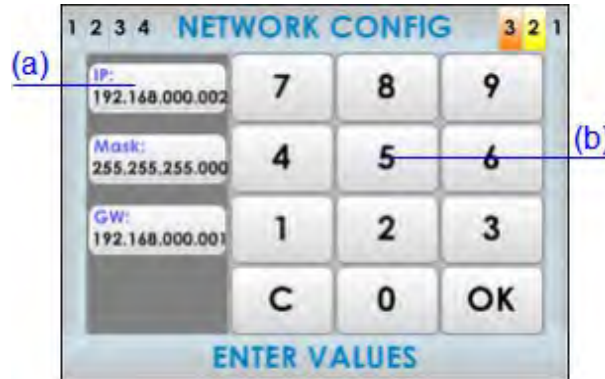

Picture 40: Network Configuration Window

#### (g) DATE AND TIME SETTINGS/ IDENTIFY EQUIPMENT

It allows you to set the date and time manually.

NOTE: When linking the equipment to the Configuration software, the equipment will be automatically synchronized with the PC's date and time.

When the selected equipment is an Extension unit (not the number 1), this button will change and allows you to identify the equipment visually. When pressing the button, the frontal led light of the selected item will blink for a few seconds.

#### (h) DISCOVER / UNLINK EQUIPMENT

The discover button searches for all the Extension units connected in the network. The equipment units found will be shown in the system's equipment list buttons.

When the selected equipment is an Extension unit (not the number 1), this button will change and allows you to unlink an equipment from the system.

## 4 CONNECTION AND SETUP

### 4.1 EMERGENCY SUPPLY SYSTEM

The equipment requires an external emergency power supply to work as an EN 54 voice evacuation system. This power supply system must manage the battery charge and monitor the status of the external batteries that will provide the required power in case of loss of normal power supply. The requirements of the emergency power supply can be found in chapter 7 . The connection diagram of emergency power supply is shown in picture 41.

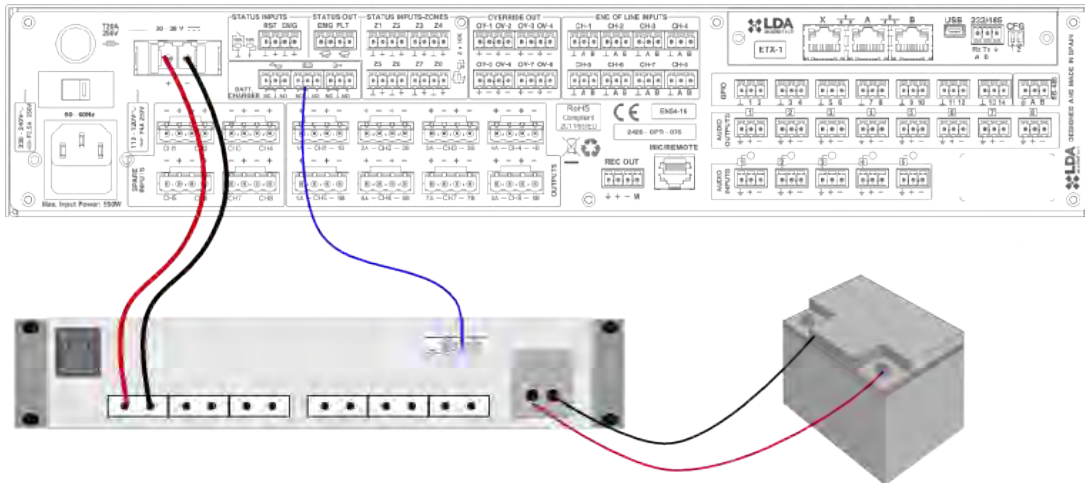

Picture 41: Emergency power supply diagram

The emergency supply system must be able to provide emergency power supply to the system for at least 30 minutes in operation and at least 24 hours in standby mode following suggestion of EN54-14 standard.

Select certified batteries, follow the set up instructions and maintenance instructions specified by the manufacturer of the battery charger.

NOTE: Supervision's Interface can be different depending on the manufacturer. Please pay attention to the meaning 'N.O' and 'N.C' of the manufacturer. LDA's equipment shows 'N.O.' referring to a normally open circuit (without failure).

## 4.2 PAGING MICROPHONES AND PA ELEMENTS (ACSI BUS)

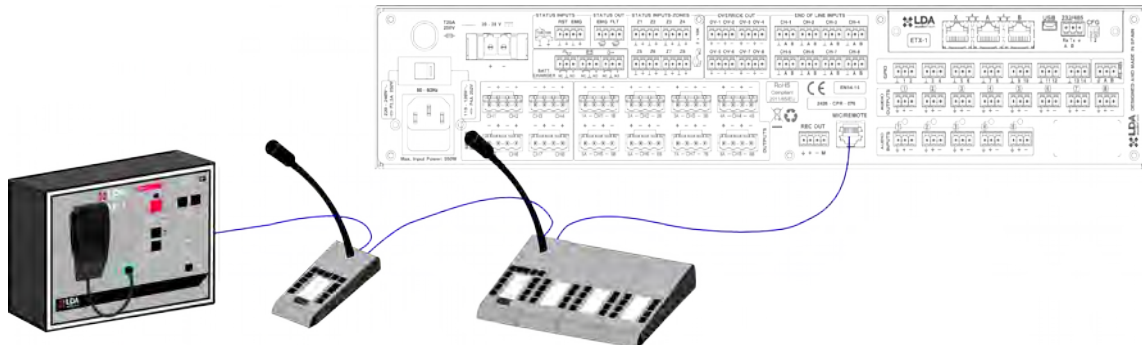

Picture 42: Public Address connection devices

The equipment has a connection for Public Address elements, such as microphones, remote panels, etc. The type of connection for all these elements is in bus mode. Each device is connected one after another, until a maximum of 8 devices, and a maximum total distance of cable of 1000m.

Each device has a direction selector. Depending on the configured priority set in the device it will allow you to occupy the channel when is occupied by other device. To configure the priority of each device inside the bus, the configuration application must be used. If no priority has been configured, the direction in which each device is set up inside the bus will be used as order of priority. When in an ACSI bus there are multi-zone microphones and remote panels, the latter would be set higher priority in the bus, implementing therefore the priority order between different panels, and between different microphones.

NOTE: When the ACSI bus is being used, the audio input n°5 will be disabled. (see section 3.5.2)

## 4.3 FLEXNET CONNECTION

FlexNet is a protocol of communication developed by LDA Audio Tech, that allows the transmission of both digital audio and control data, using a standard Ethernet network. The system ensures the maximum level of quality and reliability, as it is based in the transmission of digital audio using the CobraNet.

With FlexNet, all the compatible devices can be interconnected without the need of an external network. To provide a greater robustness and simplicity, in the case of failure in the link, the connection between devices will still continue to maintain its integrity by automatic management of primary and redundant links of each system.

Through FlexNet, from the system controller, you will have access to the configuration, control and basic motorization of the devices connected in the system. For a more advanced configuration of FlexNet and of interconnected elements through this system, its necessary to use the configuration software.

To make a FlexNet connection between compatible devices, connect the ports as shown in Picture 43. Make sure all devices are part of the same network (see section 3.5.2)



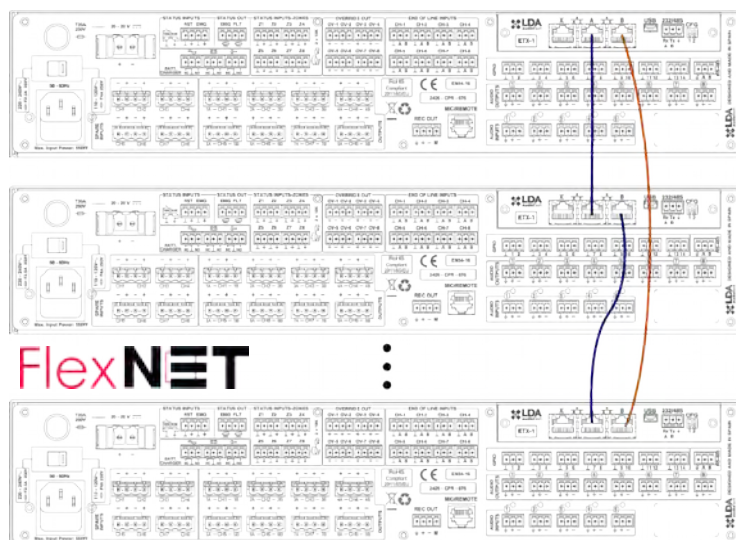

Picture 43: FlexNet

The bandwidth that Flexnet occupies in the standard Ethernet network is of 25Mb/s. On Ethernet networks of 100Mb/s, it works at network layer 2 for audio and layer 3 for communications.

Operation of the connection between NEO devices:

The return connection to the port B will be generally on standby. It will activate automatically if a loss of connection between devices is detected. If connection can not be recovered, it will turns again on standby and a 'LINK' failure will be shown until a manual reboot. In case that the system works correctly using the redundant link, the system will show the following failure: 'Network backup link active'.

#### 4.4 VOICE EVACUATION ZONES

The voice evacuation zones define those physical areas that contain a group of voice alarm speakers with same evacuation message. One evacuation zone may have one or more amplification channels. In order to set up the voice evacuation zones, use the configuration application.

#### 4.5 BACK-UP AMPLIFICATION

The equipment has the option of working with an internal back-up amplifier. This option is selectable from the configuration application. When it is activated, the last channel of the equipment will be used as a back-up of the other integrated amplifiers and, therefore, it can not be used to cover one of the voice alarm zones. When a malfunction is detected in one of the amplification channels, there will be an automatic switch to the back-up amplification channel that will occur in less than 10 seconds. If the detected problem is fixed, it will switch again automatically to the main amplifier. If a second amplifier fails during the malfunction of a main amplifier, the back-up amplifier will not automatically switch as long it is busy with the previous malfunction.

The back-up channel is constantly monitored as well as the rest of the integrated amplifiers. It is not possible to assign one voice evacuation zone to the back-up channel because the zone of the replaced amplifier will be automatically assigned.

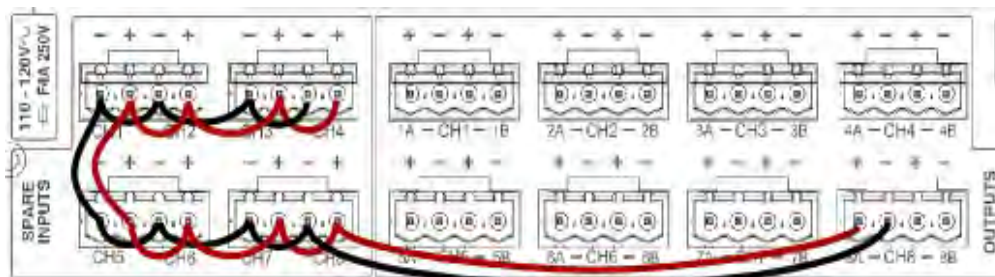

Picture 44: Back-up amplifier connection

To make a connection, you must use the same cabling system that was used in the line of speakers for voice evacuation zones.

## 4.6 SPEAKER LINES

The equipment has 8 independent amplification channels, each of them with two speakers line outputs. The power amplification of each channel is distributed in both lines so their impedance of each parallel line can not be lower than the nominal amplifier impedance. This feature enables great flexibility in the speaker connections, allowing the connection of redundant speaker lines for the same evacuation zone.

In Appendix C: Cabling section for speaker lines. can be found a table guide that is used for the calculation of which cabling section should be implemented in the installation depending on the power and length of the cable.

### 4.6.1 LINE CABLING. STANDARD MODE

The wiring of the speakers follows a classic scheme. A single cable can connect all the speakers that belong to the same amplifier channel. This wiring system can be used with or without end of lines devices (see 4.6.4). This way, the channel power amplification is distributed by one single output line.

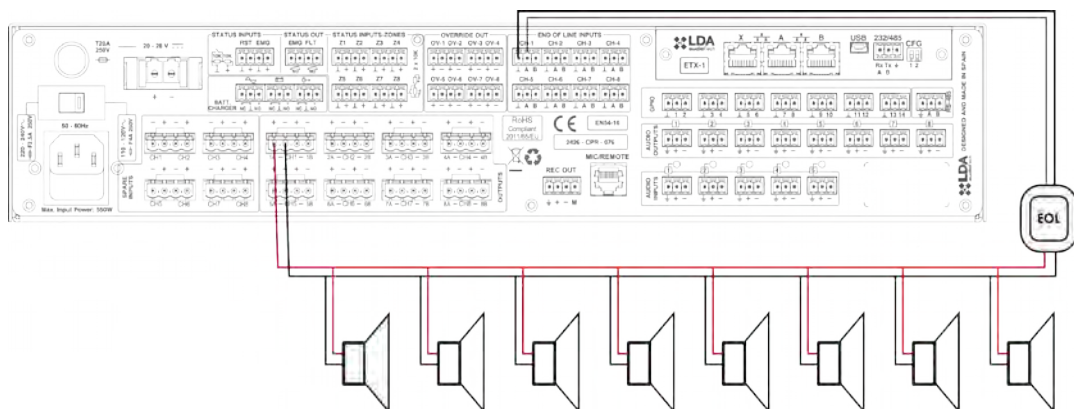

Picture 45: Speaker lines. Standard mode

### 4.6.2 LINE CABLING. AB MODE

The wiring of speakers using the AB mode allows wiring guide of one same voice evacuation system, using two different routes. This way, it reduces the risk of completely losing the connection of a zone which requires voice evacuation in case of damage to one of the lines. This wiring format can be used with or without end of line devices (see 4.6.4). This way, the channel power amplification is distributed on both output lines.

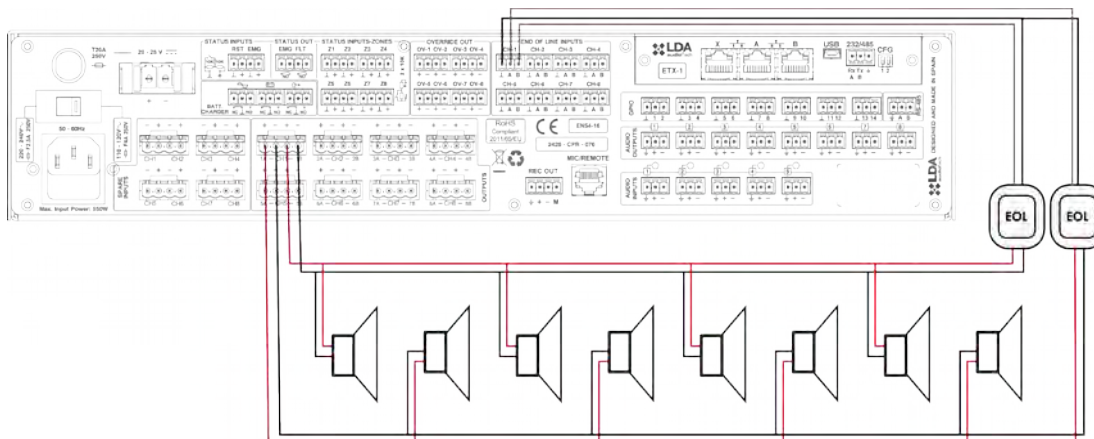

Picture 46: Speaker lines. AB Mode

#### 4.6.3 SUPERVISION OF SPEAKER CONNECTIONS

Every speaker connection is supervised independently. There are two complementary ways to do it: Measuring line impedance and end of line devices. Using the impedance of the line, the device emits a signal periodically every 30 seconds, in a non audible frequency. Consequently, in a complementary way, to increase the measure of precision of an open circuit, the end of line devices are used (see 4.6.4), to detect the injected signal, at the end of the speaker line. If the measure is inside the expected values, a signal is sent to the control system.

For a correct measure of the speaker connections, the system must be calibrated using configuration application in the following cases:

- It switches on for the first time.
- Some changes are taking place in the connected speakers, such as:
  - Some units have been added.
  - Some units have been reduced.
  - The adjustment settings of one or various units have been changed.
  - The model of one or various speakers have been changed.

To disable the measurement of loudspeaker lines or the end of line devices, use the application configuration.

NOTE: Impedance measurement is not compatible with installed attenuators in the line, due to they will modify the impedance of the line in a non-linear way.

#### 4.6.4 END OF LINE DEVICES

The end of line device (also called EOL) provides greater accuracy in monitoring speaker lines. If no end of line devices are to be installed, it must be disabled by the configuration application.

EOL devices improve the detection of loudspeaker lines in open circuit, but can not detect where it has occurred.

The EOL device has two connectors, one for connection to speaker lines in orange and another one in green for connections to 'End of line inputs' or to another EOL devices.

The connection is made via 2-pin sockets and pitch 5,08 mm (supplied with the kit). The range of cable sizes for each pole of this connector is: 0,5 2,5mm<sup>2</sup> (22 12 AWG).



Picture 47: End of line device



Indicator	Description	Type	Signals	Activation
<b>Orange</b>	Speaker lines connection	Input	<b>AB</b>	19KHz pilot tone
<b>Green</b>	Connection to EOL inputs	Output	<b>CD</b>	Voltage-free contact closure between C and D (NC)

Table 20: Connector of the EOL

NOTE: Do not connect the EOL device to the secondary side of a volume controller. This can make the device not to work properly.

### Technical Specifications

Model	EOL
Indicator	Activity (red color)
Input	Input for 100V PA lines, max consumption 15mA, input for 100V PA lines, max consumption 15mA, 2 Euroblock Pin (orange color)
Output	Isolated contact closure output, NC, Max 60V DC 130 mA, 2 Euroblock Pin (Green color)
Design	ABS, Black RAL9005
Weight	29 gr / 1oz
Dimensions (A x H x P)	66,3mm x 20mm x 50mm / 2,61in x 0,79in x 1,97in
Accessories	Male Euroblock connectors

### Views (Measurements in mm)

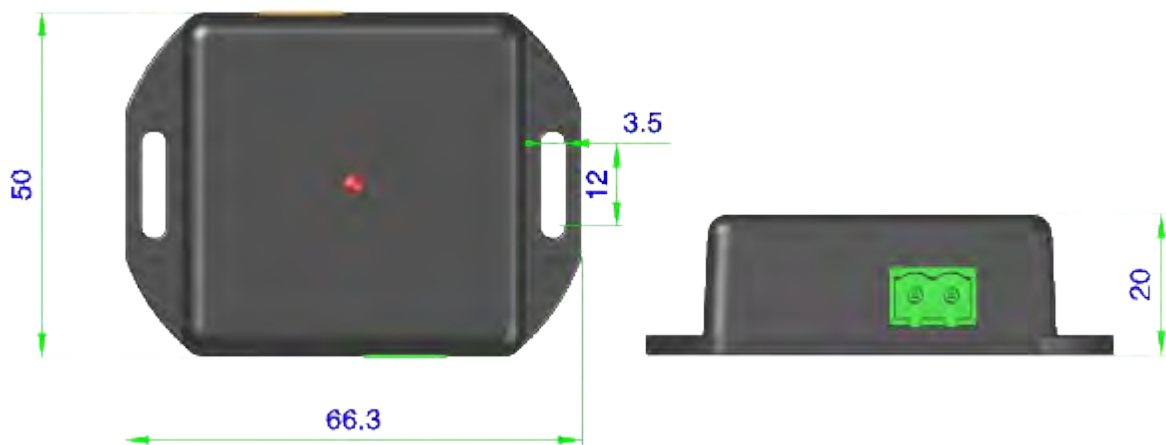

Picture 48: EOL views

### EOL installation

1. Connect the two wires from the end of the speaker lines to the line terminator input.
2. Connect the two output cables of the end of line device to the line of input correspondent to the “END OF LINE INPUTS”

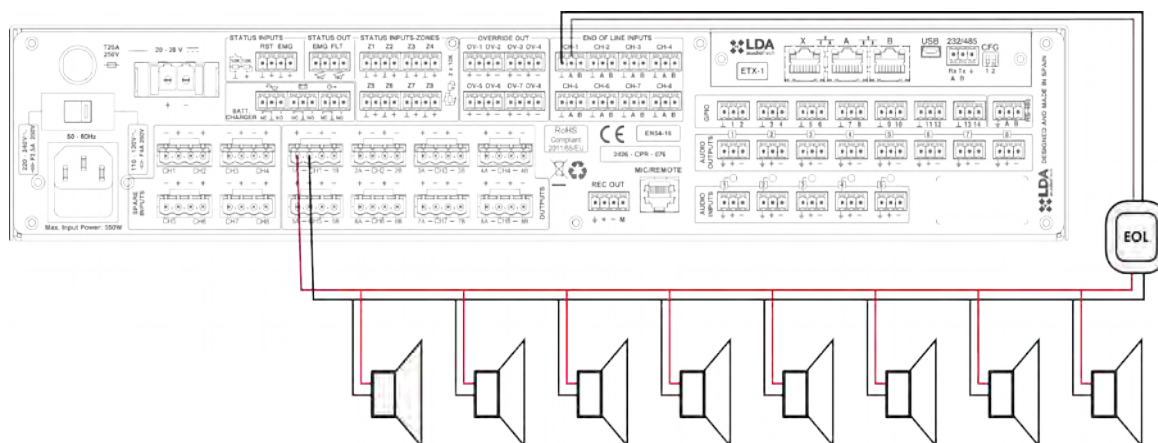

Picture 49: Connection of EOL device to the speaker line

### Installation of the end of line device in a sequence

With a configuration in sequence it is possible to supervise various sections of one line of speakers. To make a multiple connection, the end of line devices that belong to one same amplification channel, must be connected in sequence.

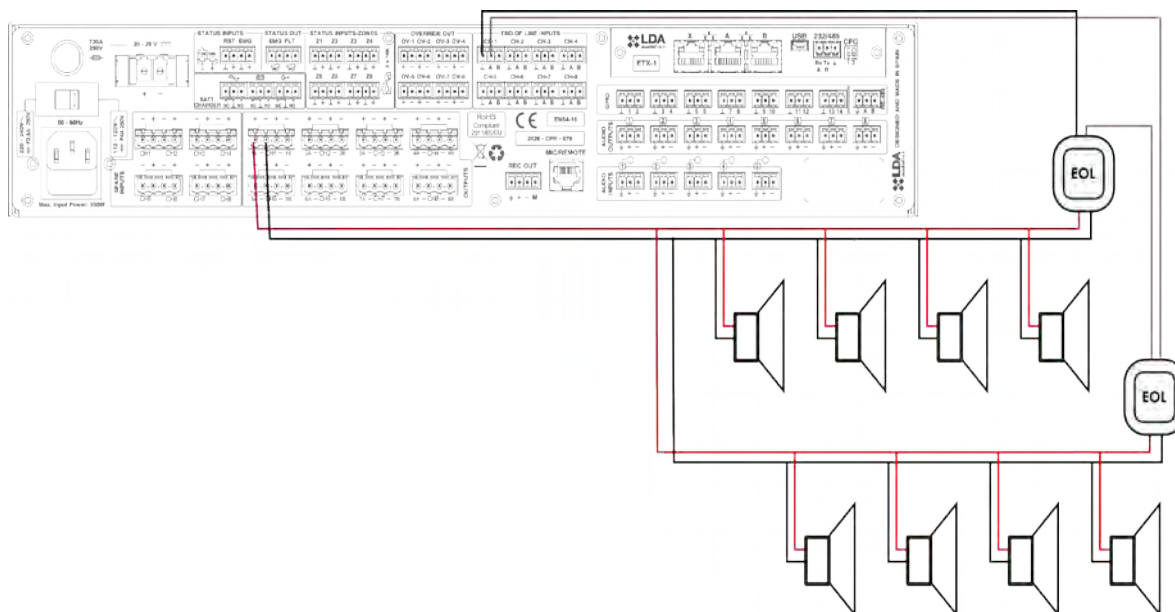

Picture 50: Multiple connection to end of speaker lines.

#### 4.7 VOLUME CONTROLLERS

The device has 8 outputs for volume controls 24V (4-wires). The maximum number of attenuators that can handle each output must be calculated from the technical characteristics (see chapter 7). The connection of the end of line devices must be done in parallel, respecting the indicated polarity:

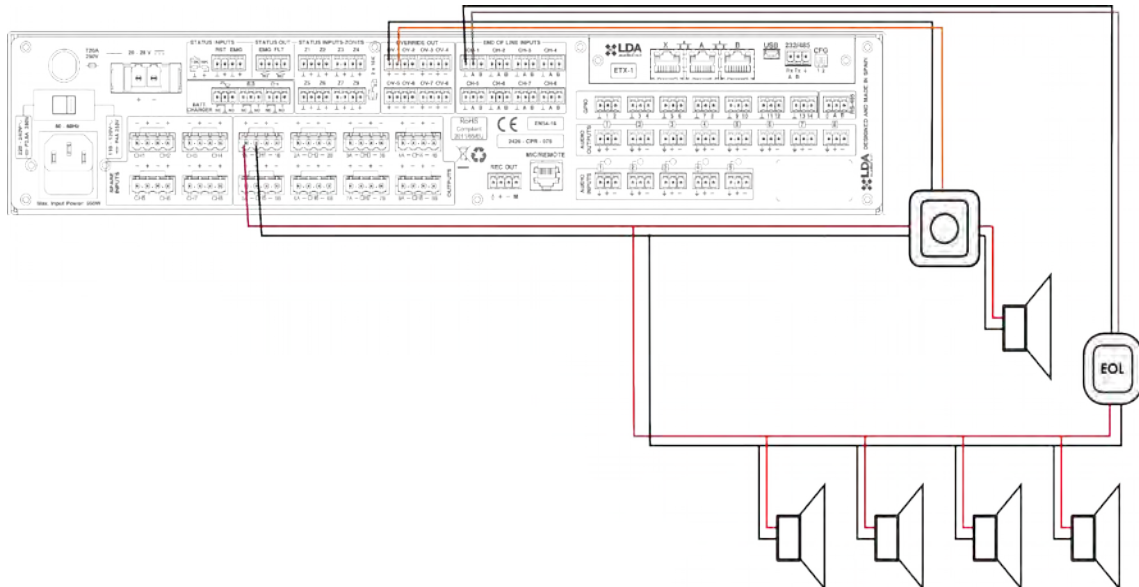

Picture 51: Volume Controller connection

**NOTE:** After a volume controller you must not connect an end of line device, as it can cause a failure detection system of the speaker line.

## 5 FAILURE DETECTION

### 5.1 SPEAKERS LINE

The system will indicate a failure in the speaker's line in case a short circuit or an open circuit has been detected or the impedance of the line has varied by at least 14%.

If this error occurs, check the specified line in the system error log. To do this, disconnect the speaker's line and measure the impedance between the cable terminals with an impedance measuring equipment. Check that the values correspond to those expected according to the number and power of existing speakers in the line. Check that there is no short circuit between any terminal and earth. If any of these measures is beyond the expected values, leave the line disconnected and check the status of the line and speakers to detect the problem.

### 5.2 TRANSMISSION LINE WITH CIE

The system will indicate a failure with the CIE transmission when it detects that the transmission path is shorted or disconnected.

If this error occurs, check the connection between the system and the CIE has been carried out in accordance with section 2.4.2. To debug the failure, disconnect the two ends of the cable connected between the CIE and equipment and measure between the cable terminals with a multimeter on the scale k $\Omega$ . If the measure result 0, the line is shorted. If the result is 1, it means that is open. If the result is 20k $\Omega$  then the line is correct. In either of the first two cases, replace or repair the transmission line.

### 5.3 PROTECTION DEVICES

The system will indicate a failure of protection when any of the internal protective devices of the equipment are active.

If this failure occurs, the amplification channel/s that have the power protection indicator, have overheated. In that case, make sure the equipment has an adequate ventilation, make sure the air inlets and outlets are not blocked. The equipment has been protected to prevent serious damage. It is possible that if you turn off your equipment, it run again after several minutes. Avoid this mode because it can cause severe damage. To avoid damaging the equipment, turn off the voice alarm zones where the failed occurred and notify it to the support service.

### 5.4 POWER SUPPLY

The system will indicate a power failure in any of these situations:

Main power supply: There was a failure in the main power supply. If this error has occurred, check that the power supply network reaches the equipment. If so, disconnect the equipment from mains and check the fuse at the input socket on the rear. If the fuse is broken, replace it. If you restart the fuse and it brakes again, call your support service.

Redundant power supply: There was a failure in the redundant power supply. Check the correct operation of it, following the manufacturer's instructions. If it works properly, check that the transmission lines between the equipment and the redundant power supply are correct as shown on section 4.1.

If in addition to indicate a power supply failure, failure is indicated in one of the amp channels, It can be that one of them has suffered a breakdown. To avoid damaging the equipment, turn off the voice alarm zones where the failure occurred, and seek support service.

### 5.5 LINK

The system will indicate a link failure when there is a problem in the way of communication between distributed devices. If this failure occurs, you can see which are the equipment connected to the controller, in the window system, of the advanced options menu (3.5.2). Restart the equipment that is down. If the problem persists, ensure that the connection between the two is correct (4.3).

## 5.6 SYSTEM

The system will indicate a system failure when a problem has occurred in the execution of the software, or memory. If after several reboots, the problem persists, connect the equipment to the configuration application and restore the version of firmware. Do not forget to restore the site data backup after restore. After this operation, the equipment should function normally, if not, contact your support service.

## 6 MAINTENANCE INSTRUCTIONS

The equipment/system requires a reduced periodical maintenance.

The periodicity of the maintenance must be adjusted in function of the condition of installation of the equipment/device. It is advisable that the maximum period for maintenance of the equipment should be of one year.

### **Operations:**

- Clean the entrance and exit ports of air with a vacuum cleaner.
- Check the connections of the equipment and the ground connection.

### **Warnings:**

- Use only a soft, lint-free cloth.
- Disconnect the equipment from any external power source.
- Disconnect all external devices.
- Keep away from liquids.
- Do not use aerosol sprays, solvents, or abrasives.
- Do not spray cleaner directly on the device.



## 7 TECHNICAL FEATURES

Data (Model)	
AC Power	110-120V / 220-240V~ 50/60Hz.
Consumption - (NEO8060) - (NEO8250E) - (NEO4250E) - (NEO4500E) - (NEO4500LE)	550W max / 120W a 1/8 output power / 40W Standby 900W max / 300W a 1/8 output power / 50W Standby 900W max / 260W a 1/8 output power / 58W Standby 900W max / 350W a 1/8 output power / 60W Standby 900W max / 350W a 1/8 output power / 55W Standby
Frequency response	80 - 20.000Hz +/-3dB (NEO4500LE 40Hz-20khz +/-3dB)
Signal to noise ratio	>95dB, A-weighted
Distortion factor	<0,05% according to 60268-3 (-10dBV)
Gain adjustment per channel	-100dB -0dB, 1dB steps
DSP	Integrated. 48 kHz, 24 bits - 344 MIPS
FlexNet	3 x redundant FlexNet (auto switch), Ethernet10/100Mbits. Female RJ-45
Audio inputs - (NEO8060) - (NEO4500LE)	5 x Balanced audio 1Vrms. 10 K $\Omega$ , 3Pin, Euroblock type 4 x Balanced audio 1Vrms. 10 K $\Omega$ , 3Pin, Euroblock type
PRI0 audio inputs. - NEO-Extension units	1 x Balanced audio 1Vrms. 10 K $\Omega$ , 3Pin, Euroblock type
ACSI Bus input (NEO8060)	1 x Balanced audio 1Vrms. 10 K $\Omega$ , female RJ-45, 1000m of max. length.
Pre-amp Audio Outputs	4/8 x Balanced audio 1Vp, 0,707Vrms. 100 $\Omega$ , 3Pin, Euroblock type
Audio output / Ctrl (NEO8060)	1 x Balanced audio, 1Vp, 0,707Vrms. 100 $\Omega$ / 0 - 5V DC output 100 $\Omega$ , 4Pin, Euroblock type.
Attenuators over-ride	4/8 x Override 24V DC, 40mA, 2 Pin, Euroblock type (4 pin connector)
Emergency control inputs	6 /10 x 0-5V DC, supervised, 2 Pin, Euroblock type (4 pin connector)
Emergency control outputs	2 x Relay Contract isolated output, NO, Max 60V DC 130mA, 2 Pin, Euroblock Type (4 pin connector)
GPIO (NEO8060)	14 x GPIO, 0-5 V, 100 $\Omega$ , 3Pin, Euroblock type
Virtual Audio Matrix	40 x 1024
Amplifiers - (NEO8060) - (NEO8250E) - (NEO4250E) - (NEO4500E) - (NEO4500LE)	8 x Class D, 120W/60Wrms @70/100V.Min load 83 $\Omega$ Min Cap 10nF 8 x Class D, 250W/112Wrms @70/100V.Min load 80 $\Omega$ Min Cap 10nF 4 x Class D, 250W/250Wrms @70/100V.Min load 40 $\Omega$ Min Cap100nF 4 x Class D, 800W/500Wrms @70/100V.Min load 40 $\Omega$ Min Cap100nF 4 x Class D, 250Wrms@8 $\Omega$ / 500Wrms@4 $\Omega$ . Max Cap100nF
Speakers outputs	8 (4ch) or 16 (8ch) fo A+B channels 2 Pin, Euroblock type (4 pin connector)
Speakers loop inputs	8 - 16 (8 dual) x Voltage free dy contacts, 3 Pin, Euroblock type.
Back-up amplifiers inputs	1 input per channel, for amplifier with equal power.
Protection	Over-Temperature, DC, Infrasonic, short-circuit, slow start-up, overload, start-up test.
Emergency Power Input	1 x 20 - 28V DC, Protected by fuse, 2 Pin, Euroblock Type (2 pin connector)
	3 x Voltage-free contact closure inputs tension NO - NC, 3 Pin,

Emergency Power Status Input	Euroblock Type
Display Screen	TFT 480 x 272, 4,3" with resistive touch panel
Operating conditions	-5 °C to +45 °C / 23 °F to 113 °F 5% to 95% Relative Humidity (no condensation)
Finish	Front: Fe, Grey RAL 7016 Rear: Fe, Black RAL 9005 Case: Al, Black RAL 9005
Weight - (NEO8060) - (NEO8250E) - (NEO4250E) - (NEO4500E) - (NEO4500LE)	12kg 14kg 7,6kg 7,7kg 7,8kg
Dimensions (W x H x D)	483mm x 88mm x 455mm / 19" x 3,46" x 18"
Accessories	2 x Rack Mounting, Male Euroblock Type Connection, Installation Screw, 4 x Rubber foot, 1 x Power Cable 2m / 6,56ft (EU Type), 1 x Ethernet Cable 2m / 6,56ft.



## 8 Appendix A: EN 54-16 features

NEO implements all mandatory functions for compliance with the EN54- 16: 2008. It includes the following optional features certified:

1. Audible warning
2. Phased evacuation
3. Manual mute of the voice alarm state
4. Manual reset of the voice alarm state
5. Exit voice alarm condition
6. Fault Indication regarding the transmission path with the CIE (central fire alarm system)
7. Fault indication on the voice alarm zones
8. Disable state
9. Manual control of voice alarm
10. Interface to external control devices
11. Emergency microphone
12. Redundant Power Amplifiers

### Extra Features

1. Distribution of background music programs
2. Multi-zone microphones management
3. Independent DSP per each I/O audio channel
4. Pre-recorded message player
5. LDA Sound Enhancer
6. Record output
7. Control output for attenuators
8. Input Parametric Equalizer with 7-band per channel
9. Output Parametric Equalizer with 7-band per channel
10. Loudness Compensation



## 9 Appendix B: LOG Content

### 9.1 STATE OF EMERGENCY LOG

- EMG State ACTIVE(Local)
- EMG State ACTIVE(Remote)
- EMG State RESET
- EMG State ACK
- EVAC MSG ON (Zone X)
- EVAC MSG OFF (Zone X)
- ALERT MSG ON (Zone X)
- ALERT MSG OFF (Zone X)
- EMIC ON (Zone X)
- EMIC OFF (Zone X)

### 9.2 STATE OF FAILURE LOG

- EMG POWER FLT
- MAIN POWER FLT
- CIE PATH FLT
- CIE PATH FLT on device XXX
- REMOTE CIE PATH FLT
- CIE PATH FLT RST
- NETWORK LINK FLT
- PROTECT FLT Amp Ch X
- PROTECT FLT Fuse X
- EMIC FLT (Local/Remote)
- LINE X FLT Open Circuit
- LINE X FLT Close Circuit
- LINE X Invalid Measurements
- SYSTEM FLT Safe Mode
- SYSTEM FLT Configuration

### 9.3 STATE OF DISARMED LOG

- DIS STATE Zone X Disabled
- DIS STATE Zone X Enabled



## 10 Appendix C: Cabling section for speaker lines.

The table below reflects the maximum desirable distance for 100V speaker lines. The type of cable that is used for the calculations is a two-wire type with copper conductor. The values shown may be used as a guide for planning, being the responsibility of the installer who will make the appropriate final calculations for each case.

The table shows the output power of typical amplification channels, constant voltage 100V in effective watts (rms) are expressed. The maximum length for 70V lines is half of what is reflected in the table.

Section			Maximum length with 5% of loss of power				
AWG	! mm	mm <sup>2</sup>	60Wrms	120Wrms	240Wrms	480Wrms	960Wrms
6	4,11	13,3	3260	1630	810	405	200
7	3,67	10,6	2600	1300	645	320	160
8	3,26	8,35	2050	1025	510	255	130
9	2,91	6,62	1625	810	405	200	100
10	2,59	5,27	1300	645	320	160	80
11	2,3	4,15	1020	510	255	130	65
12	2,05	3,31	810	405	200	100	50
13	1,83	2,63	645	320	160	80	40
14	1,63	2,08	510	255	130	65	35
15	1,45	1,65	405	200	100	50	25
16	1,29	1,31	320	160	80	40	20
17	1,15	1,04	255	130	65	35	15
18	1,02	0,82	200	100	50	25	13

Table 21: Section of cabling for lines of 100V

Caption:

- AWG (American Wire Gauge): American Wire Gauge. Classification according to USA standard diameters.
- mm cable diameter in millimeters
- mm<sup>2</sup>: Cross-sectional area in square millimeters cable

## Index of Pictures

Picture 1: Indicators.....	2
Picture 2: Controls.....	4
Picture 3: Control window.....	5
Picture 4: Zone selection window.....	6
Picture 5: Types of Control Access Window.....	7
Picture 6: Inputs and Outputs.....	8
Picture 7: Monitoring inputs for the back-up power supply.....	8
Picture 8: Emergency Activation Interface.....	9
Picture 9: Supervised connection with the CIE.....	9
Picture 10: General Emergency Activation Input.....	9
Picture 11: System Status Outputs.....	10
Picture 12: Emergency-Zone activation inputs.....	10
Picture 13: Attenuators override outputs.....	11
Picture 14: EOL device inputs.....	11
Picture 15: External Systems Slot Interface.....	12
Picture 16: USB Port.....	12
Picture 17: Integration Serial Port.....	12
Picture 18: AC Line voltage selector.....	14
Picture 19: Main power supply input.....	14
Picture 20: Emergency Power Supply Fuse.....	14
Picture 21: Emergency Power Supply Input.....	14
Picture 22: Back up amplifiers inputs.....	15
Picture 23: Speaker Lines Outputs.....	15
Picture 24: REC output.....	16
Picture 25: ACSI Bus Input.....	16
Picture 26: Pre-amp outputs.....	17
Picture 27: Audio Source Inputs.....	17
Picture 28: GPIO ports.....	18
Picture 29: Bus RS-485 for CIE.....	18
Picture 30: PA Menu Window.....	23
Picture 31: Zones volume setting Window.....	24
Picture 32: Route sources Window.....	25
Picture 33: Advanced Options Menu.....	26
Picture 34: Audio Input Setting Window.....	26
Picture 35: Audio Output Setting Window.....	28
Picture 36: Monitor Window.....	29
Picture 37: Message Window.....	30
Picture 38: Load Preset Window.....	31
Picture 39: System's Advanced Options Window.....	32
Picture 40: Network Configuration Window.....	33
Picture 41: Emergency power supply diagram.....	34
Picture 42: Public Address connection devices.....	35
Picture 43: FlexNet .....	36
Picture 44: Back-up amplifier connection.....	37
Picture 45: Speaker lines. Standard mode.....	37
Picture 46: Speaker lines. AB Mode.....	38
Picture 47: End of line device.....	39
Picture 48: EOL views.....	40
Picture 49: Connection of EOL device to the speaker line.....	40
Picture 50: Multiple connection to end of speaker lines.....	41
Picture 51: Volume Controller connection.....	41

## Index of tables

Table 1: Emergency Source Monitor Inputs.....	8
Table 2: General Emergency Inputs.....	10
Table 3: System status outputs.....	10
Table 4: Emergency-zone activation inputs.....	11
Table 5: Attenuators override outputs.....	11
Table 6:EOL device inputs.....	11
Table 7: Integration serial port.....	13
Table 8: System connection configuration.....	13
Table 9: Line Voltage Selector.....	14
Table 10: Main Power Supply Input.....	14
Table 11: Emergency Supply Input.....	15
Table 12: Spare Channel Inputs.....	15
Table 13: Speaker Lines Outputs.....	16
Table 14: REC Output.....	16
Table 15: ACSI bus Input.....	17
Table 16: Pre-amp/Line-level outputs.....	17
Table 17: Audio Source Input.....	18
Table 18: GPIO ports.....	18
Table 19: CIE Advanced Port Integration through RS-485.....	19
Table 20: Connector of the EOL.....	39
Table 21: Section of cabling for lines of 100V.....	51

**Ver. 1.1**  
**05- 2017**