

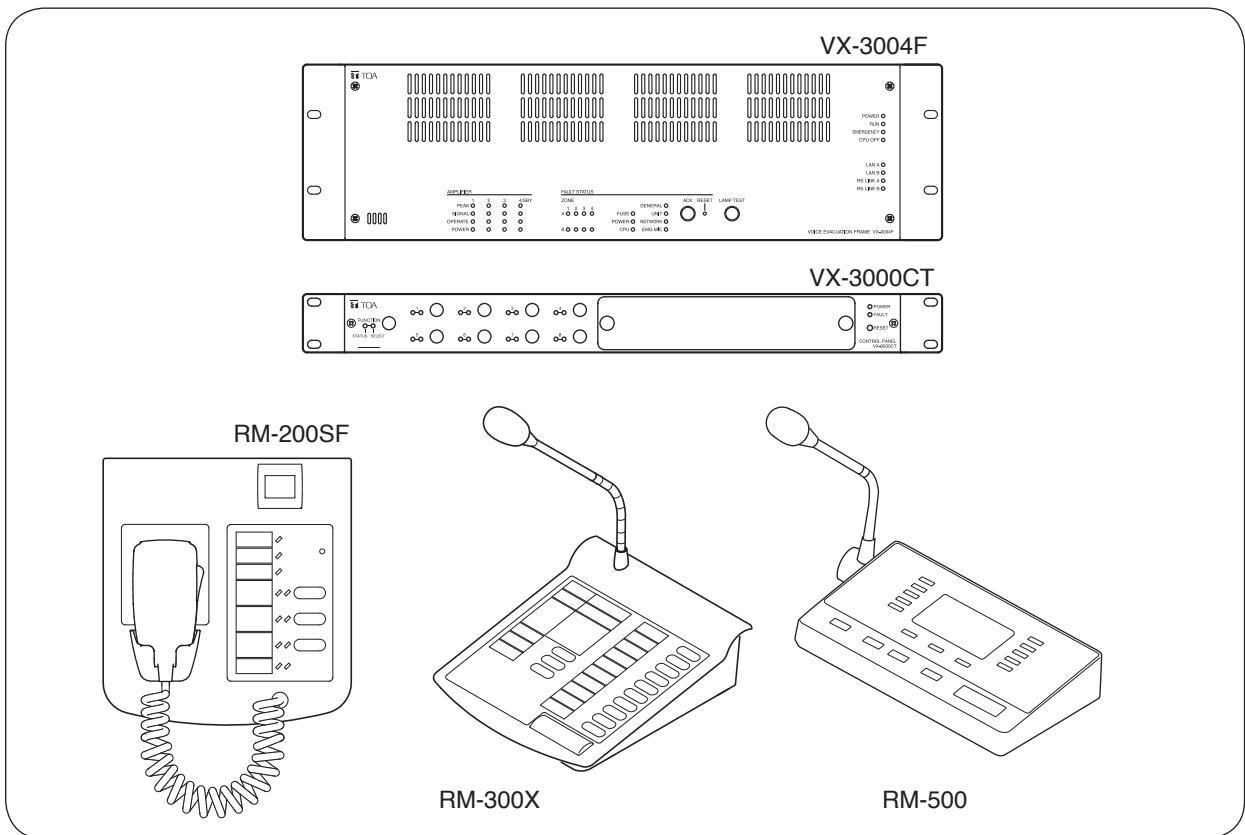

OPERATING INSTRUCTIONS

INTEGRATED VOICE EVACUATION SYSTEM VX-3000 SERIES



Thank you for purchasing TOA's Integrated Voice Evacuation System.
Please carefully follow the instructions in this manual to ensure long, trouble-free use of your equipment.

TABLE OF CONTENTS

Chapter 1 : NOMENCLATURE

1. VX-3004F, VX-3008F, AND VX-3016F VOICE EVACUATION FRAME	1-2
2. RM-200SF FIREMAN'S MICROPHONE AND RM-320F REMOTE MICROPHONE EXTENSION	1-6
2.1. RM-200SF	1-6
2.2. RM-320F	1-8
3. RM-300X REMOTE MICROPHONE AND RM-210F REMOTE MICROPHONE EXTENSION	1-9
3.1. RM-300X	1-9
3.2. RM-210F	1-10
4. RM-500 REMOTE MICROPHONE	1-11

Chapter 2 : INDICATOR STATUS OF CONTROL PANEL AND REMOTE MICROPHONES

1. VX-3000CT CONTROL PANEL	2-2
1.1. Indicator State at the Time of Input Volume Adjustment	2-2
1.2. Indicator State at the Time of Output Volume Adjustment	2-2
1.3. Indicator State at the Time of Zone Selection	2-3
1.4. Indicator State at the Time of Base Pattern Change	2-4
1.5. Indicator State at the Time of General-Purpose Broadcast Pattern	2-4
1.6. Indicator State at the Time of General/BGM Broadcast	2-5
1.7. Indicator State at the Time of Intended Control Input	2-6
1.8. Indicator State at the Time of Intended Control Output (Pulse)	2-7
1.9. Indicator State at the Time of Intended Control Output (Level)	2-7
1.10. Indicator State at the Time of Zone Volume Adjustment (Pulse)	2-8
1.11. Indicator State at the Time of Input Volume Adjustment (Pulse)	2-9
1.12. Indicator State at the Time of Emergency Warning Broadcast	2-10
1.13. Indicator State at the Time of Sleep Mode Power On	2-11
2. RM-200SF FIREMAN'S MICROPHONE AND RM-320F REMOTE MICROPHONE EXTENSION	2-12
2.1. Indicator State at the Time of Zone Selection	2-12
2.2. Talk Key Indicators	2-13
2.3. Indicator State at the Time of Base Pattern Change	2-14
2.4. Indicator State at the Time of General-Purpose Broadcast Pattern	2-14
2.5. Indicator State at the Time of General/BGM Broadcast	2-15
2.6. Indicator State at the Time of RM Broadcast Status Display	2-15
2.7. Indicator State at the Time of Lamp Test	2-16
2.8. Indicator State at the Time of Failure Output Receipt	2-17
2.9. Indicator State at the Time of Failure Output Reset	2-18
2.10. Indicator State at the Time of Emergency Broadcast Pattern Start	2-19
2.11. Indicator State at the Time of Emergency Broadcast Pattern Stop	2-20
2.12. Indicator State at the Time of Emergency Broadcast Pattern Start/Stop	2-21

2.13. Indicator State at the Time of Emergency Sequence Stop	2-22
2.14. Indicator State at the Time of Emergency Sequence Phase Shift	2-23
2.15. Indicator State at the Time of Emergency Reset	2-24
2.16. Indicator State at the Time of Emergency Broadcast Silence	2-25
2.17. Indicator State at the Time of Emergency EV Broadcast	2-26
2.18. Indicator State at the Time of Emergency Acknowledge	2-27
2.19. Indicator State at the Time of Disablement of EMG Control from CIN	2-29
2.20. Indicator State at the Time of Audio Monitor	2-30
2.21. Indicator State at the Time of Intended Control Input	2-31
2.22. Indicator State at the Time of Intended Control Output (Pulse)	2-32
2.23. Indicator State at the Time of Intended Control Output (Level)	2-33
2.24. Indicator State at the Time of Zone Volume Adjustment (Pulse)	2-34
2.25. Indicator State at the Time of Input Volume Adjustment (Pulse)	2-35
2.26. Indicator State at the Time of Emergency Warning Broadcast	2-36
2.27. Indicator State at the Time of Sleep Mode Power On	2-37

3. RM-300X REMOTE MICROPHONE AND RM-210F REMOTE MICROPHONE EXTENSION

3.1. Indicator State at the Time of Zone Selection	2-38
3.2. Talk Key Indicators	2-39
3.3. Indicator State at the Time of Base Pattern Change	2-39
3.4. Indicator State at the Time of General-Purpose Broadcast Pattern	2-40
3.5. Indicator State at the Time of General/BGM Broadcast	2-40
3.6. Indicator State at the Time of RM Broadcast Status Display	2-41
3.7. Indicator State at the Time of Lamp Test	2-41
3.8. Indicator State at the Time of Failure Output Receipt	2-42
3.9. Indicator State at the Time of Failure Output Reset	2-43
3.10. Indicator State at the Time of Emergency Broadcast Pattern Start	2-44
3.11. Indicator State at the Time of Emergency Broadcast Pattern Stop	2-45
3.12. Indicator State at the Time of Emergency Broadcast Pattern Start/Stop	2-46
3.13. Indicator State at the Time of Emergency Sequence Stop	2-47
3.14. Indicator State at the Time of Emergency Sequence Phase Shift	2-48
3.15. Indicator State at the Time of Emergency Reset	2-49
3.16. Indicator State at the Time of Emergency Broadcast Silence	2-50
3.17. Indicator State at the Time of Emergency EV Broadcast	2-51
3.18. Indicator State at the Time of Emergency Acknowledge	2-52
3.19. Indicator State at the Time of Disablement of EMG Control from CIN	2-54
3.20. Indicator State at the Time of Audio Monitor	2-55
3.21. Indicator State at the Time of Intended Control Input	2-55
3.22. Indicator State at the Time of Intended Control Output (Pulse)	2-56
3.23. Indicator State at the Time of Intended Control Output (Level)	2-56
3.24. Indicator State at the Time of Zone Volume Adjustment (Pulse)	2-57
3.25. Indicator State at the Time of Input Volume Adjustment (Pulse)	2-58
3.26. Indicator State at the Time of Emergency Warning Broadcast	2-59
3.27. Indicator State at the Time of Sleep Mode Power On	2-60

4. RM-500'S LCD SCREEN DISPLAY

4.1. Indicator State at the Time of Zone Selection	2-63
4.2. Talk Indicator and Microphone Indicator	2-64
4.3. Indicator State at the Time of Base Pattern Change	2-65
4.4. Indicator State at the Time of General-Purpose Broadcast Pattern	2-66
4.5. Indicator State at the Time of General/BGM Broadcast	2-67
4.6. Indicator State at the Time of RM Broadcast Status Display	2-68

4.7. Indicator State at the Time of Intended Control Input	2-69
4.8. Indicator State at the Time of Intended Control Output (Pulse)	2-70
4.9. Indicator State at the Time of Intended Control Output (Level)	2-71
4.10. Indicator State at the Time of Zone Volume Adjustment (Pulse)	2-72
4.11. Indicator State at the Time of Input Volume Adjustment (Pulse)	2-73
4.12. Indicator State at the Time of Emergency Warning Broadcast	2-74
4.13. Indicator State at the Time of Sleep Mode Power On	2-75

Chapter 3 : OPERATION

1. BGM AND GENERAL BROADCAST	3-2
1.1. Broadcasting from the Remote Microphone or the Control Panel	3-2
1.2. Assignment Example	3-2
1.3. Operation Examples	3-3
1.4. Emergency Warning Broadcast	3-9
2. OPERATION OF THE RM-500	3-10
2.1. Selecting Items on the LCD Screen	3-10
2.2. Making Microphone Announcements	3-11
2.3. Making Microphone Announcements in Direct Selection Mode	3-13
2.4. Making the AUX Broadcast	3-14
2.5. Activating Various Functions	3-15
2.6. Locking Keys	3-16
3. EMERGENCY BROADCAST	3-17
3.1. Typical System Examples	3-17
3.2. Remote Microphone Operation Example	3-19
4. MAKING ALL-ZONE EMERGENCY BROADCAST	3-25
4.1. Priority Control of the All-Zone Emergency Broadcast	3-25
4.2. Making All-zone Emergency Broadcast from the RM-300X	3-26
4.3. Making All-zone Emergency Broadcast from the RM-200SF	3-27
5. DETECTING FAULT	3-28
5.1. Fault Detection Setting Example	3-28
5.2. Case Example of Malfunction	3-29
5.3. Remote Microphone's Operation Example	3-30
5.4. VX-3004F's Operation Example	3-31
5.5. Example of Executing the Failure Reception and Failure Reset by Way of the Control Input Terminals	3-32
6. LAMP TEST	3-33
6.1. Remote Microphone's Operation Example	3-33
6.2. VX-3004F's Operation Example	3-34
7. OTHER FUNCTIONS	3-35
7.1. Audio Monitor	3-36
7.2. Intended Control Input Operation	3-37
7.3. Intended Control Output Operation (Pulse)	3-37
7.4. Intended Control Output Operation (Level)	3-38
7.5. Switching VX-3000 Amplifier's Power State between Active (ON) and Sleep Modes	3-39

Chapter 1

NOMENCLATURE

1. VX-3004F, VX-3008F, AND VX-3016F VOICE EVACUATION FRAME

VX-3004F, VX-3008F, and VX-3016F are collectively referred to as “VX-3000F” in this manual.

- The VX-3000F is a unit designed to control the Voice evacuation announcements of the VX-3000 series voice evacuation system.
- The VX-3000F is equipped with the audio input terminals and has the module slots for optionally accommodating 3 kinds of digital power amplifier modules and a line output module.
- Compatible with network, the system can be configured in distributed arrangement.

[Front]

VX-3004F

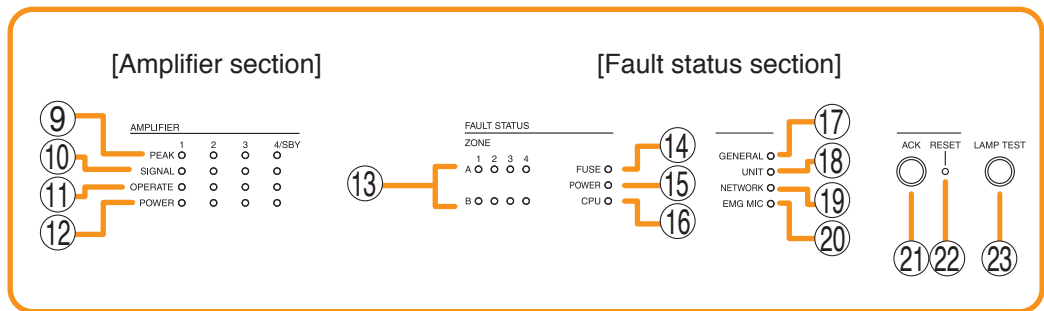
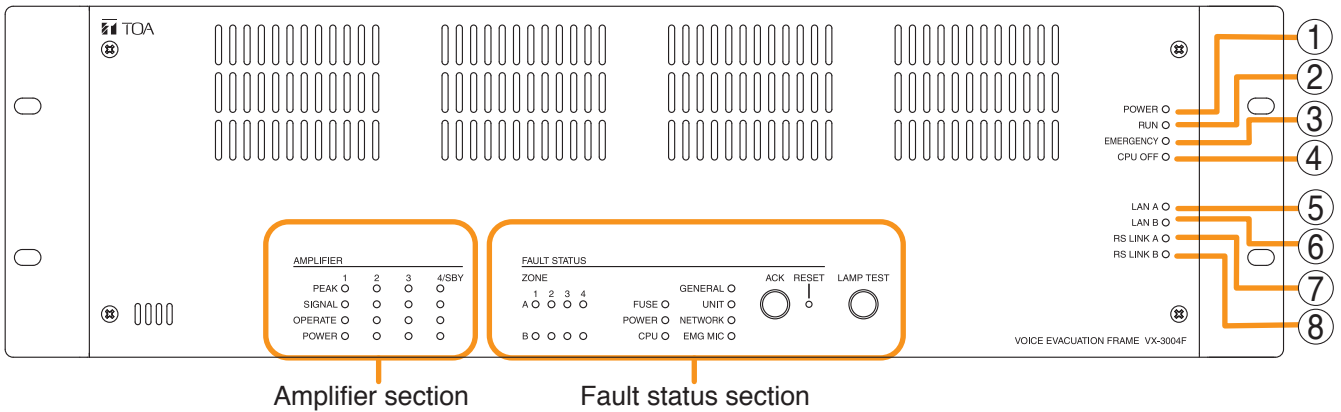

VX-3008F

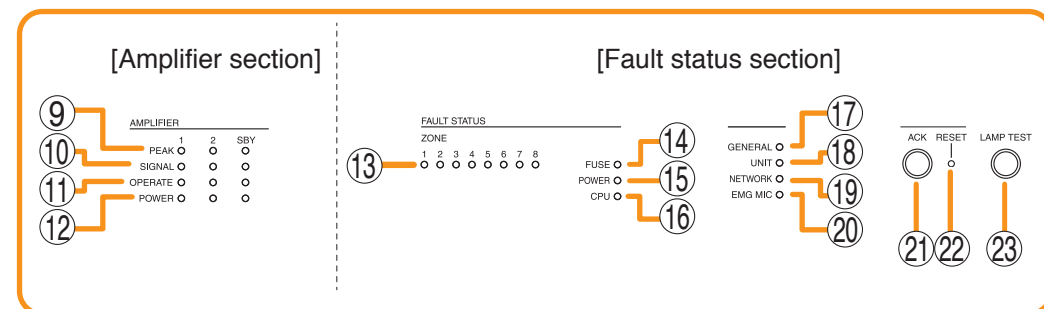
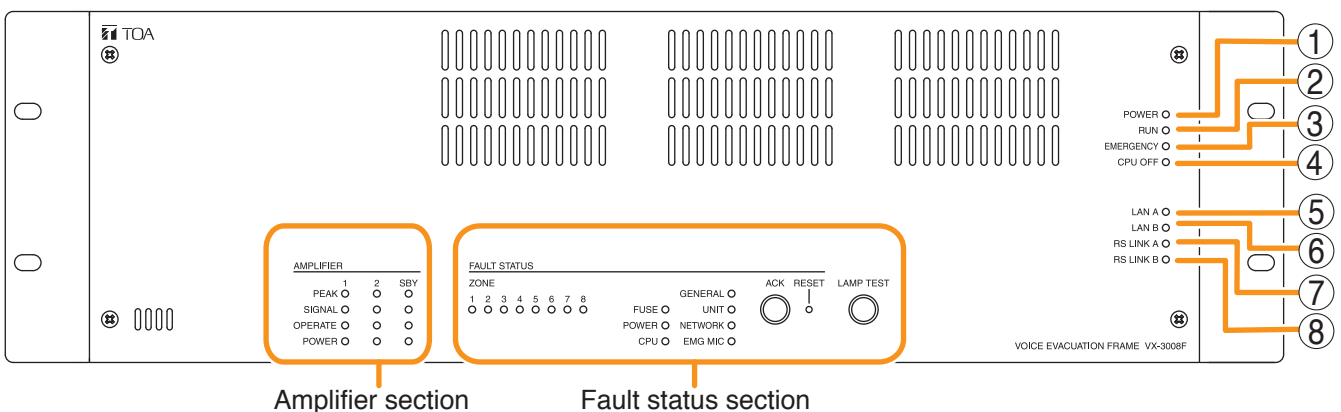

VX-3016F

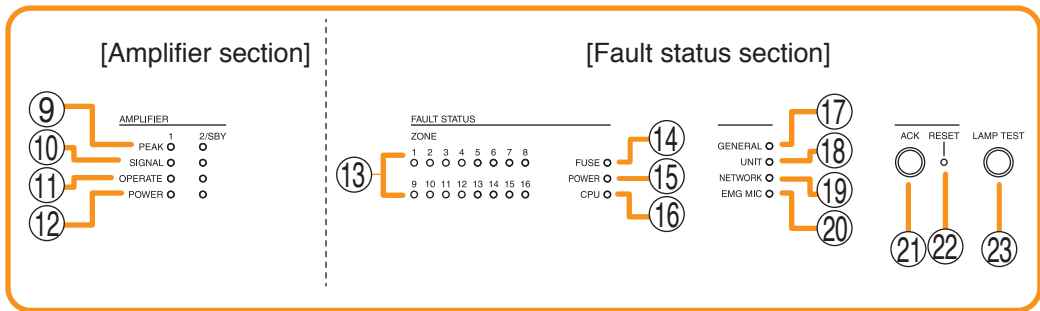
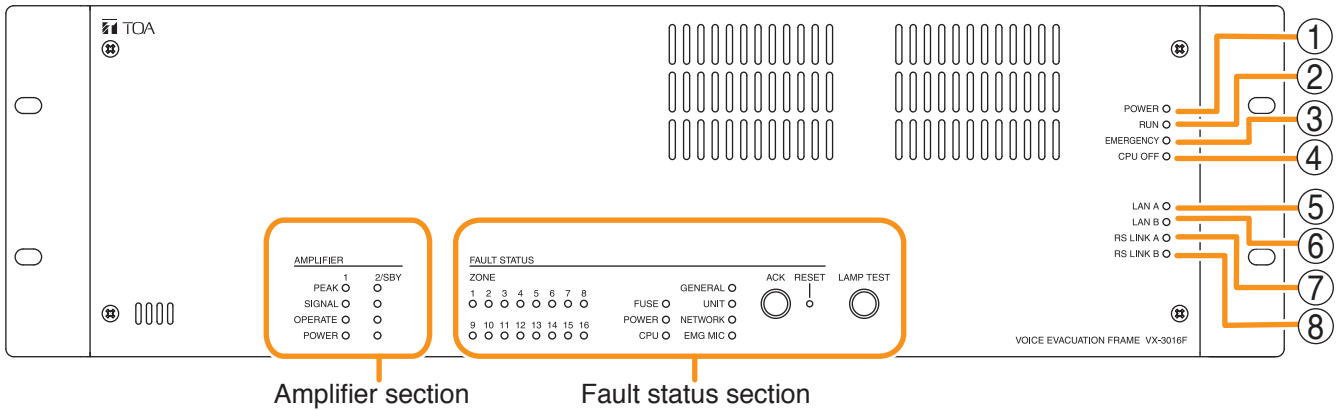

1. Power indicator (Green)

Lights when the power is supplied.
Flashes in standby state.

2. RUN indicator (Green)

Normally flashes continuously. Goes off while in a CPU off state (p. 3-25). Also goes off while in standby state*1.

*1 A state during power failures or a state that the unit is internally initialized after power-on

3. Emergency indicator (Red)

Lights when the VX-3000 system is in an emergency condition or while in a CPU off state (p. 3-25).

4. CPU off indicator (Red)

Lights while in a CPU off state (p. 3-25).

5. LAN A indicator (Green)

Lights when the LAN link A connector on the rear panel is connected, and flashes during LAN communications.

6. LAN B indicator (Green)

Lights when the LAN link B connector on the rear panel is connected, and flashes during LAN communications.

7. RS link A indicator (Green)

Lights when the RS link A connector on the rear panel is connected, and flashes while communications are being performed via the RS link A connector.

8. RS link B indicator (Green)

Lights when the RS link B connector on the rear panel is connected, and flashes while communications are being performed via the RS link B connector.

9. Amplifier peak indicators (Red)

Show the input signal state to the power amplifier when the module is installed.

The indicator corresponding to the module slot port will light if the input signal level exceeds +0.5 dB*2.

It remains unlit when no module is installed.

10. Amplifier signal indicators (Green)

Show the input signal state to the power amplifier when the module is installed.

The indicator corresponding to the module slot port will light if the input signal level exceeds -25 dB*2.

It remains unlit when no module is installed.

*2 0 dB = 1 V

11. Amplifier operate indicators (Green)

The indicator corresponding to the module slot port will light or go off depending on the operation state of the power amplifier when the power amplifier module is installed.

Operating status	Indicator status
In-use	Lit
Standby	Unlit
DC fuse blowout	Unlit
Protection* activated	Unlit

* The built-in protection circuit operates if some irregularities occur inside the amplifier such as abnormal temperature rise or fan failure.

It remains unlit when the line output module is installed.

It remains unlit when no module is installed.

12. Amplifier power indicators (Green)

The indicator corresponding to the module slot port will light or go off depending on the operation state of the power amplifier when the power amplifier module is installed.

Operating status	Indicator status
In-use	Lit
Standby	Lit
DC fuse blowout	Unlit
Protection* activated	Lit

* The built-in protection circuit operates if some irregularities occur inside the amplifier such as abnormal temperature rise or fan failure.

It remains unlit when the line output module is installed.

It remains unlit when no module is installed.

13. Zone fault indicators (Yellow)

Lights or flashes when the speaker line surveillance function detects 3 types of failures: poor insulation (ground fault), overload (line short), and cable disconnection.

14. Fuse fault indicator (Yellow)

Lights or flashes when DC fuse blowout are detected.

15. Power fault indicator (Yellow)

Lights or flashes when failures are detected in Power Supply Manager.

16. CPU fault indicator (Yellow)

Lights while in a CPU off state (p. 3-25) or when a failure is detected in the VX-3000F.

17. General fault indicator (Yellow)

Lights while in a CPU off state (p. 3-25) Lights or flashes when a failure is detected in the system.

18. Unit fault indicator (Yellow)

Lights or flashes when a failure is detected in the unit.

19. Network fault indicator (Yellow)

Lights or flashes when failures are detected in communications with the other VX-3000F.

It also flashes or lights at network setting and when a configuration error occurs.

20. Emergency microphone fault indicator (Yellow)

Lights or flashes when failures are detected in Emergency Microphone.

21. Fault ACK key

The buzzer will sound and Fault indicator will flashes when a failure is detected in the system. Press this key to stop the buzzer and switches the Fault indicator from flashing to steady on.

22. Fault reset key

Pressing this key resets the failure information (the buzzer and fault indicators) for the system.

23. Lamp test key

Used to test each indicator on the front panel of the VX-3000F Voice Evacuation Frame.

All indicators remain lit and the buzzer sounds as long as this key is pressed.

1. VX-3000CT CONTROL PANEL

- The VX-3000CT is a 1U size*¹ Control panel mountable in an EIA standard equipment rack.
- Operation such as the activation of general broadcast and the input/output volume control can be performed by connecting the VX-3000CT to the VX-3000F via network. Up to 2 VX-3000CT units can be connected to a single VX-3000F unit.
- The VX-3000CT unit is equipped with 9 function keys and 8 volume controls, to each of which a function can be assigned using the VX-3000 Setting Software.

*¹ 1U size = 44.5 mm (standard size)

[Front]

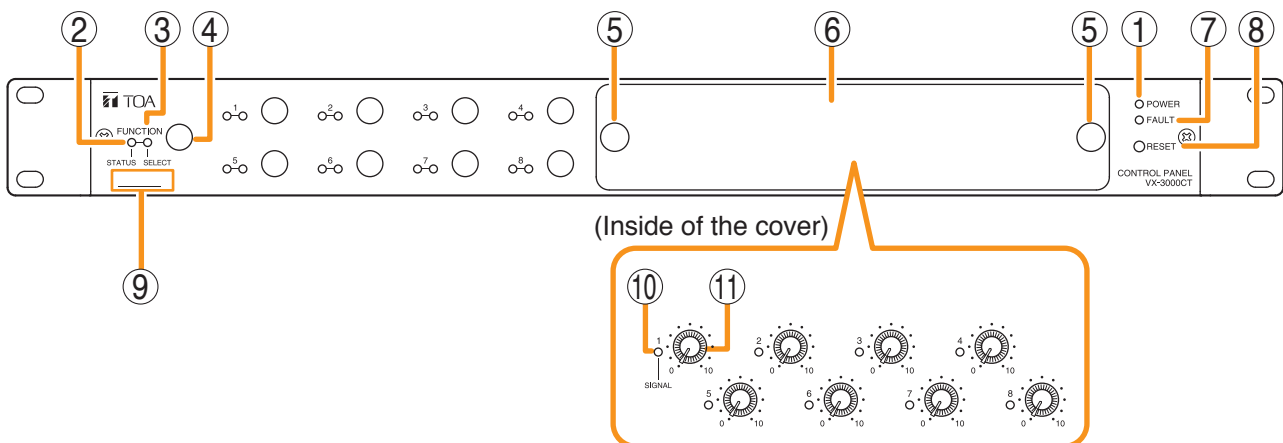

1. Power indicator (Green)

Lights when power is being supplied.

2. Status indicator (Yellow/Green)

Lights yellow or green, or goes off in synchronization with the operation state of the function key. (See pages 2-3 to 2-11.)

3. Selection indicator (Green)

Lights or goes off in synchronization with the operation state of the function key. (See pages 2-3 to 2-11.)

4. Function keys

Pressing a specific function key executes the function that has been assigned to that key by the VX-3000 Setting Software. Assignment of functions to specific keys is done using the VX-3000 Setting Software. (See the separate Setting Software Instructions, "VX-3000CT Setting.")

5. Volume control section cover knobs

The volume control section cover can be removed by pulling the both knobs.

6. Volume control section cover

7. Fault indicator (Yellow)

Lights when an equipment error is detected.

8. Reset key

Resets the VX-3000CT when this key is pressed.

9. MAC address

This is the MAC address*² for the unit. Since the relationship of each unit location to its MAC address is established when setting the network attributes, keep track of this relationship for later use.

*² The unit's MAC address consists of 12 hyphenated alphanumeric characters.

10. Signal indicator (Green)

Indicates the status of the input or output assigned to the Volume control (11). If the indicator functions as input signal indicator, it lights when the audio level of the input channel assigned to the Volume control (11) is $-25\text{ dB}^{\ast 3}$ or more.

If the indicator functions as output signal indicator, it lights when the audio level of the set individual output zone is $-25\text{ dB}^{\ast 3}$ or more.

The setting can be performed using the VX-3000 Setting Software.

(See the separate Setting Software Instructions, "VX-3000CT Setting.")

*³ 0 dB = 1 V

11. Volume control knobs

Adjusts the volume level of the VX-3000F's audio input or audio output in the range of $-\infty$ to 0 dB.

The volume increases as the knob is rotated clockwise, and decreases as the knob is rotated counterclockwise.

Which volume level of the input channel or the output zone is to be adjusted can be assigned to the volume control using the VX-3000 Setting Software. (See the separate Setting Software Instructions, "VX-3000CT Setting.")

2. RM-200SF FIREMAN'S MICROPHONE AND RM-320F REMOTE MICROPHONE EXTENSION

2.1. RM-200SF

- The RM-200SF Fireman's Microphone features 3 function keys, 1 emergency key, 1 talk key, and the indicator lamps associated with these keys. Functions are assigned to the function keys using the VX-3000 Setting Software.
- Specially designed for both emergency and general purpose broadcast applications, the Fireman's Microphone can be used for push-button zone selection and microphone broadcasts.
- VX-3000 setting software permits desired functions to be assigned to individual Function keys (equipped with 2 LED indicators).
- Up to 4 RM-320F Remote Microphone Extension units can be used with each RM-200SF Remote Microphone.
- Up to 2 RM-200SF Fireman's Microphones can be connected within a VX-3000F.
- The CPU switch enables all-zone emergency broadcasts from the RM-200SF Fireman's Microphone, even when the CPU malfunctions.
- Failures of Emergency buttons and signal (both control and audio) path between the microphone (including the internal microphone element) and the VX-3000F are automatically detected.

[Front]

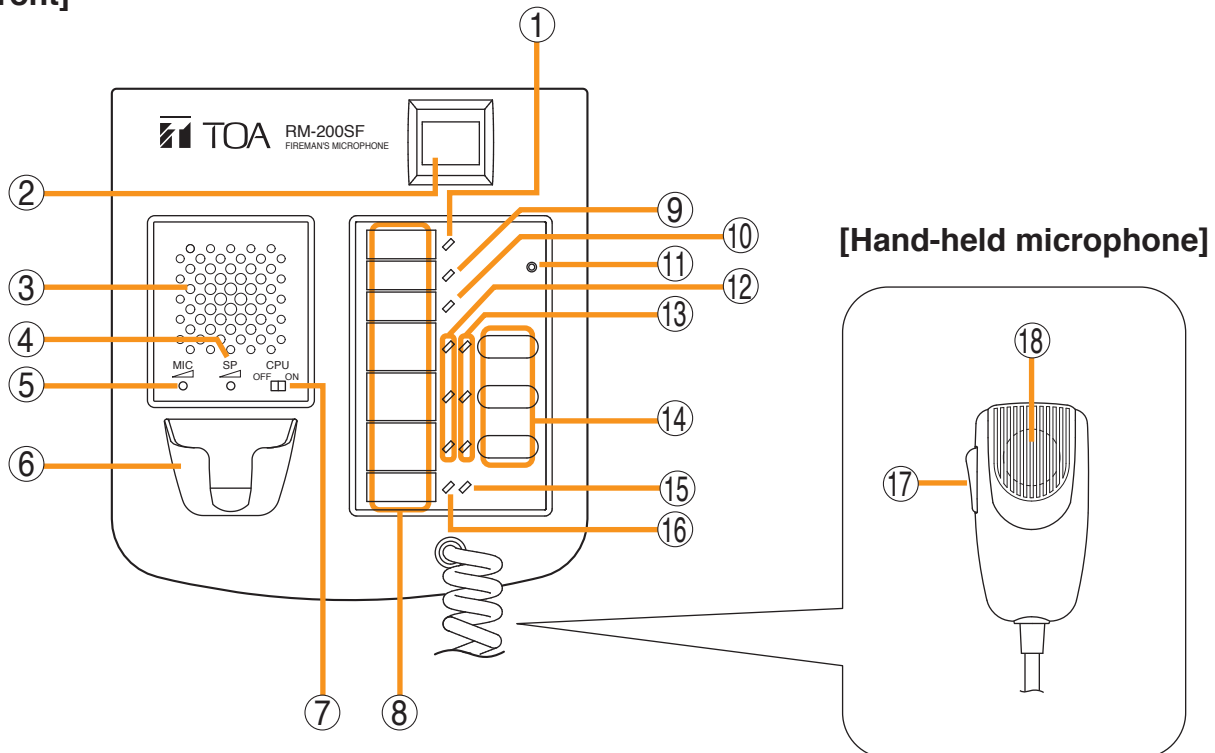

1. Power indicator (Green)

Lights when the power is turned on.

2. Emergency key

Assign the function concerning the emergency broadcast to this key using the VX-3000 Setting Software.

This key lights or flashes depending on the assigned function.

3. Monitor speaker

Used to monitor current broadcasts.

4. Monitor speaker volume control

Adjusts the volume of the built-in Monitor speaker (3).

5. Microphone volume control

Adjusts the input sensitivity of the Hand-held Microphone.

6. Microphone hanger

Used to hold the unit's Hand-held Microphone.

7. CPU switch

Normally set to ON. (Factory-preset: ON)

Setting this switch to OFF in combination with the DIP switch setting on the bottom surface allows the all-zone emergency broadcast to be made using a hand-held microphone by way of analog transmission not via the CPU control.

8. Indication label insert slot

The label can be printed using the VX-3000 Setting Software. (See the separate Setting Software Instructions, "PRINTING LABELS FOR REMOTE MICROPHONES.")

9. Failure indicator (Yellow/Red)

Flashes yellow if some problem within the system is detected.

This indicator will light yellow if the signal to the VX-3000F to which the RM-200SF is connected is interrupted for 5 seconds or more.

Lights red when the unit is placed in reset state by pressing the Reset Switch (11).

10. CPU indicator (Red)

Lights red when any one of the CPU switches on the RM-200SFs connected within the system is set to OFF or when the all-zone emergency broadcasts is being made by any one of the RM-300Xs connected within the system.

11. Reset switch

Used to reactivate the RM-200SF unit.

Holding down both this switch and the R3 key of the Function keys (14) for 2 seconds or more causes the Failure Indicator (9) to light red, placing the RM-200SF in reset state.

12. Status indicators (Red/Yellow/Green)

Light, flash, or go off depending on the current operation state of function keys, failure state or emergency state. (See the Chapter 2.)

13. Selection indicators (Green)

Light or go off depending on the current operation state of function keys. (See the Chapter 2.)

14. Function keys (R1 – R3)

Positioned in top-down order (R1, R2, R3). Pressing a specific function key executes the function that has been assigned to that key by the VX-3000 Setting Software. Assignment of functions to specific keys is done using the VX-3000 Setting Software. (See the separate Setting Software Instructions, "RM Event Settings.")

15. Microphone indicator (Green)

Lights or goes off depending on the current operation state of the Talk key.

16. Broadcast status indicator (Yellow/Green)

Lights, flashes, or goes off depending on the current operation state of the Talk key.

17. Talk key

Press this key to broadcast a voice announcement. It must be pressed continuously for the duration of the broadcast.

The talk key operation method is fixed to "PTT," and can not be changed.

18. Microphone

Used for voice announcements.

2.2. RM-320F

Each connected RM-320F Extension unit adds 20 Function keys to the base RM-200SF.

[Front]

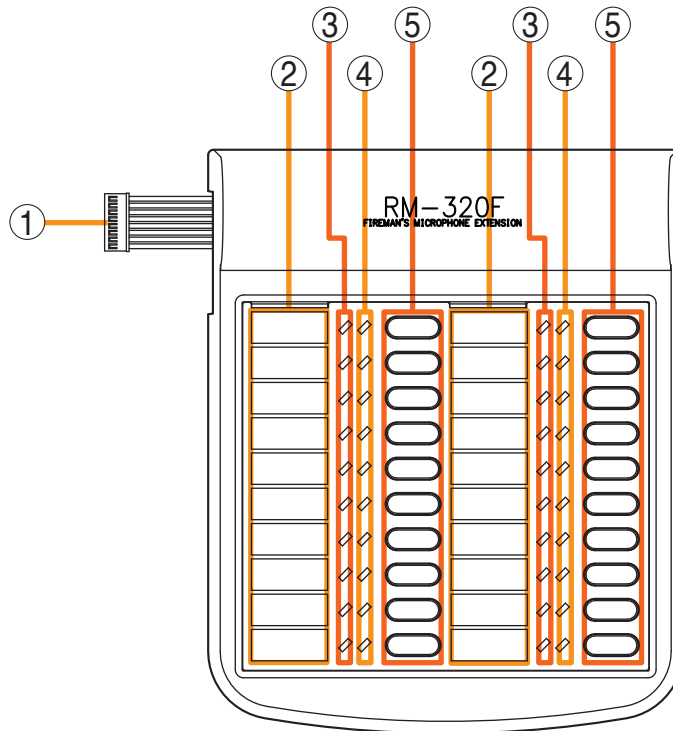

1. Connection cable

Used for connection to the RM-200SF or other RM-320F.

2. Indication label insert slot

The label can be printed using the VX-3000 Setting Software. (See the separate Setting Software Instructions, "PRINTING LABELS FOR REMOTE MICROPHONES.")

3. Status indicators (Red/Yellow/Green)

Light, flash, or go off depending on the current operation state of function keys.

4. Selection indicators (Green)

Light or go off depending on the current operation state of function keys.

5. Function keys (1 – 20)

Keys are numbered from 1 to 10 from upper left to bottom and from 11 to 20 from upper right to bottom.

Pressing a specific function key executes the function that has been assigned to that key by the VX-3000 Setting Software. Assignment of functions to specific keys is done using the VX-3000 Setting Software.

(See the separate Setting Software Instructions, "RM Event Settings.")

3. RM-300X REMOTE MICROPHONE AND RM-210F REMOTE MICROPHONE EXTENSION

3.1. RM-300X

- The RM-300X Remote Microphone features 13 function keys, 1 covered key, 1 talk key, and the indicator lamps associated with these. Functions are assigned to the function keys using the VX-3000 Setting Software.
- VX-3000 setting software permits desired functions to be assigned to individual Function keys (equipped with 2 LED indicators).
- Connecting RM-210F Remote Microphone Extension (maximum 7) to the RM-300X expands the number of function keys and indicators in blocks of 10.
- Up to 8 RM-300X Remote Microphones can be connected within a VX-3000F.
- The DIP switch setting enables all-zone emergency broadcasts from the RM-300X Remote Microphone, even when the CPU malfunctions.

[Top]

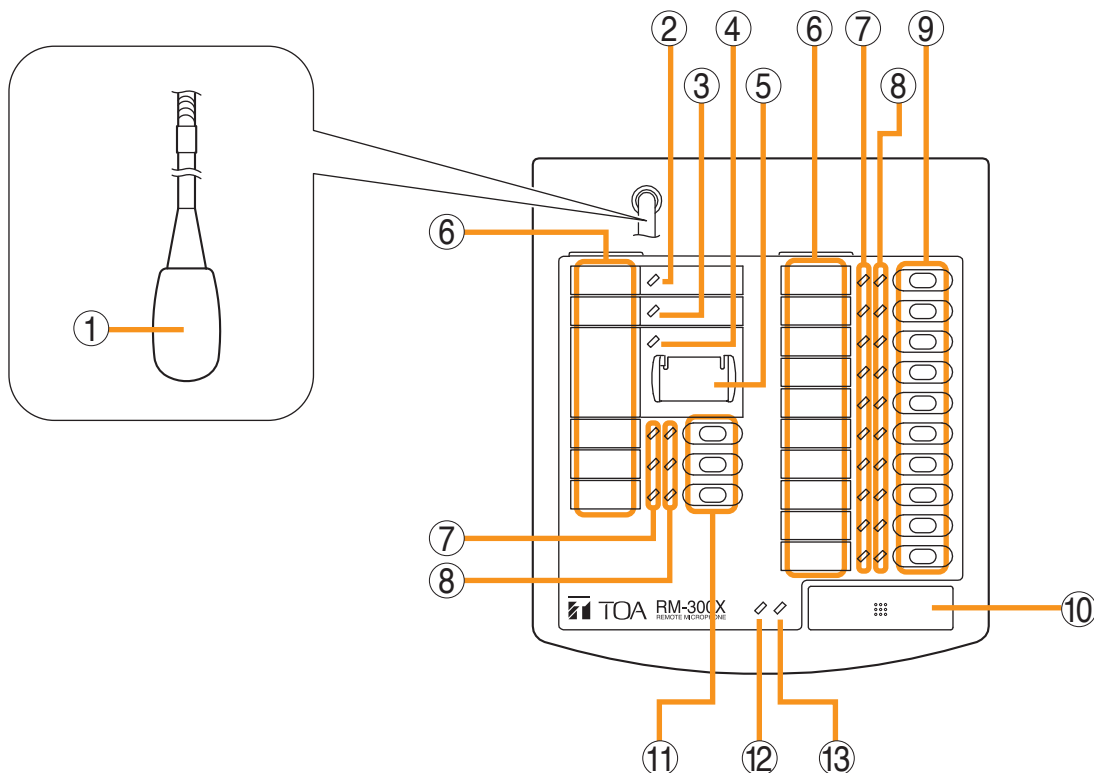

1. Microphone

Used for voice announcements.

2. Power indicator (Green)

Lights when the power is turned on.

3. Failure indicator (Yellow/Red)

Flashes yellow if some problem within the system is detected.

This indicator will light yellow if the signal to the VX-3000F to which the RM-300X is connected is interrupted for 5 seconds or more.

This indicator will light red while the all-zone emergency broadcasts is being made (p. 3-25) or the RM-300X is in the reset process.

4. Emergency indicator (Red)

Lights or flashes depending on the function assigned to the Emergency key.

5. Emergency/all-zone emergency broadcast key (Covered)

[Function concerning the emergency broadcast]
Assign the function concerning the emergency broadcast to this key using the VX-3000 Setting Software.

[Function concerning the all-zone emergency broadcast]

Independently of settings made by the VX-3000 Setting Software, holding down this key for 4 seconds or more in combination with DIP switch (14) setting causes the CPU to be bypassed, enabling the all-zone emergency broadcast to be made by way of analog transmissions. (See p. 3-25.)

6. Indication label insert slots

Labels can be printed using the VX-3000 Setting Software. (See the separate Setting Software Instructions, "PRINTING LABELS FOR REMOTE MICROPHONES.")

7. Status indicators (Red/Yellow/Green)

Light, flash, or go off depending on the current operation state of function keys, failure state or emergency state. (See the Chapter 2.)

8. Selection indicators (Green)

Light or go off depending on the current operation state of function keys. (See the Chapter 2.)

9. Function keys (R1 – R10)

Positioned in top-down order (R1, R2 ... R10). Pressing a specific function key executes the function that has been assigned to that key by the VX-3000 Setting Software.

Assignment of functions to specific keys is done using the VX-3000 Setting Software. (See the separate Setting Software Instructions, "RM Event Settings.")

10. Talk Key

Press this key to broadcast a voice announcement. If the Talk key is set to "PTT" ("press-to-talk") mode, then it must be pressed continuously for the duration of the broadcast.

If the Talk key is set to "Lock" mode, then it must be pressed once to turn the microphone on at the beginning of a broadcast, then pressed again to turn the microphone off once the broadcast is finished.

The microphone can also be set to sound a chime at the beginning and/or end of each broadcast.

The Talk key mode ("PTT" or "Lock") and the chime function are set using the VX-3000 Setting Software. (See the separate Setting Software Instructions, "Unit Configuration Setting.")

11. Function keys (L1 – L3)

Positioned in top-down order (L1, L2, L3).

These keys operate in the same manner as the Function keys (R1 – R10) (9).

12. Broadcast status indicator (Yellow/Green)

Lights, flashes, or goes off depending on the current operation state of the Talk key.

13. Microphone indicator (Green)

Lights or goes off depending on the current operation state of the Talk key. Flashes while the chime is being activated.

3.2. RM-210F

Each connected RM-210F Extension unit adds 10 Function keys to the base RM-300X.

[Top]

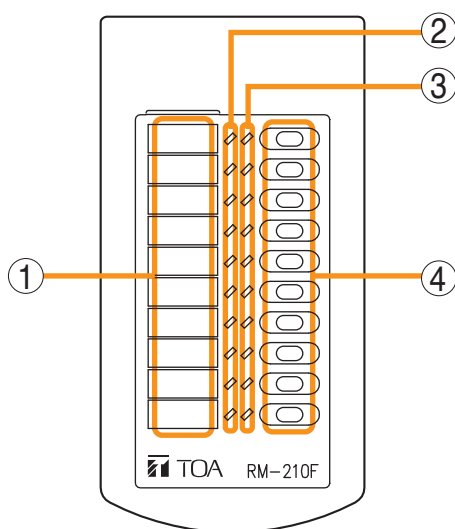
**1. Indication label insert slot**

The label can be printed using the VX-3000 Setting Software. (See the separate Setting Software Instructions, "PRINTING LABELS FOR REMOTE MICROPHONES.")

2. Status indicators (Red/Yellow/Green)

Light, flash, or go off depending on the current operation state of function keys.

3. Selection indicators (Green)

Light or go off depending on the current operation state of function keys.

4. Function keys (1 – 10)

Positioned in top-down order (1, 2 ... 10).

Pressing a specific function key executes the function that has been assigned to that key by the VX-3000 Setting Software.

Assignment of functions to specific keys is done using the VX-3000 Setting Software. (See the separate Setting Software Instructions, "RM Event Settings.")

4. RM-500 REMOTE MICROPHONE

- The RM-500 is a desktop type remote microphone designed for general broadcast.
- Equipped with an LCD screen, it can display up to 80 function names registered in advance, allowing these functions to be executed with the key operation.
- Pressing the AUX key enables the control of only the external audio signals.
- The speech intelligibility function makes it easier to hear the microphone announcements even in noisy environments, and also allows the microphone to pick up the audio signals at an appropriate level even if speaking too close to or too far from it.
- Can be mounted on the wall by using an optional wall mounting bracket.

[Top]

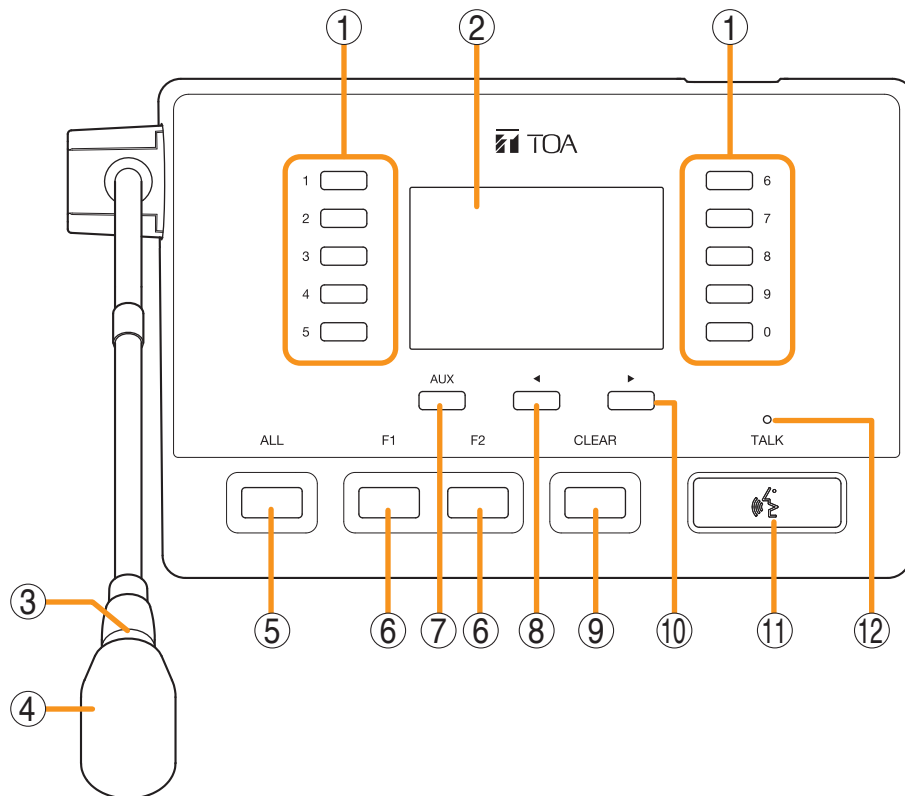

1. Numeric keys

Normally, select the item number displayed on the LCD screen. The functions set with the VX-3000 Setting software can be executed.

When the menu screen is displayed, these keys are used to select the menu item number or the option number.

2. LCD screen

Normally, displays a list of the set functions and the status of the broadcast or function.

Shifting switch 6 of the Setting switch to the ON position switches the mode to the direct selection, displaying the line number registration screen.

Shifting switch 7 of the Setting switch to the ON position switches the screen to the menu display. (See the separate Installation Manual, "RM-500 REMOTE MICROPHONE" of "NOMENCLATURE AND FUNCTIONS.")

3. Microphone indicator (green)

Lights during the microphone broadcasts. However, it does not light when announcements are being broadcast from the microphone connected to the AUX input terminal.

You can also set it to OFF by the system setting.

4. Microphone

Used for making general broadcasts.

5. ALL key

Selects the preset zones.

6. F1/F2 key

The functions set with the VX-3000 Setting software can be executed.

7. AUX key

Press this key to broadcast the audio signals fed to the AUX input terminal.

When the menu screen is displayed, pressing this key executes the operation as shown by the guide displayed in the lower left of the screen.

8. ◀ key

Press this key to move to the previous page from the current page displayed on the LCD screen. When the menu screen or the line number registration screen is displayed, pressing this key executes the operation as shown by the guide displayed in the lower center of the screen.

9. Clear key

Terminates the broadcast when pressed while broadcast is in progress.
Cancels the selection for all zones being selected in normal mode on the LCD screen.

10. ▶ key

Press this key to move to the next page from the current page displayed on the LCD screen. When the menu screen or the line number registration screen is displayed, pressing this key executes the operation as shown by the guide displayed in the lower center of the screen.

11. Talk key

Press this key to broadcast a voice announcement. Set the key operation mode to either PTT or Lock at the system setup.

If the Talk key is set to "PTT" ("press-to-talk") mode, then it must be pressed continuously for the duration of the broadcast.

If the Talk key is set to "Lock" mode, then it must be pressed once to turn the microphone on at the beginning of a broadcast, then pressed again to turn the microphone off once the broadcast is finished.

(See the separate Setting Software Instructions, "Unit Configuration Settings.")

12. Talk indicator (green)

Lights or goes off depending on the current operation state of the Talk key.

Chapter 2

INDICATOR STATUS OF CONTROL PANEL AND REMOTE MICROPHONES

1. VX-3000CT CONTROL PANEL

1.1. Indicator State at the Time of Input Volume Adjustment

When the input volume adjustment function has been assigned to the volume control knob, the Signal indicator allows you to check the audio signal state of the input channel assigned to the volume control knob.

Note

For instructions on assigning functions to volume control knobs, see the separate Setting Software Instructions, "EVENT SETTINGS."

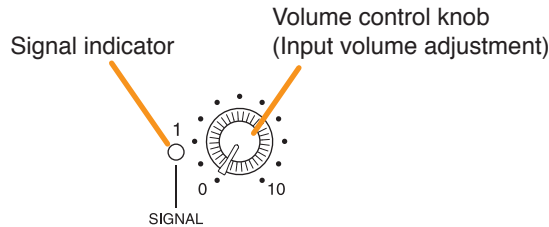

Indicator meanings are as follows:

Status		Meaning
Unlit	○	Audio signals are not applied to the input channel assigned to the volume control knob.
Lights green	●	Audio signals are applied to the input channel assigned to the volume control knob.

1.2. Indicator State at the Time of Output Volume Adjustment

When the output volume adjustment function has been assigned to the volume control knob, the Signal indicator allows you to check the audio state of the one set to the indicator of the output zones assigned to the volume control knob.

Note

For instructions on assigning functions to volume control knobs, see the separate Setting Software Instructions, "EVENT SETTINGS."

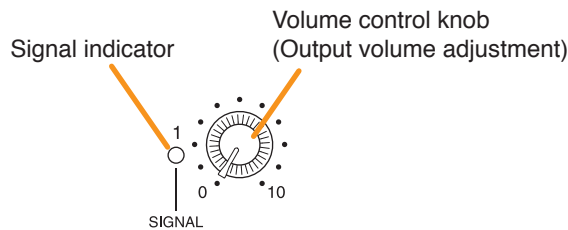

Indicator meanings are as follows:

Status		Meaning
Unlit	○	Audio signals are not output to the output zone assigned to the Signal indicator.
Lights green	●	Audio signals are output to the output zone assigned to the Signal indicator.

1.3. Indicator State at the Time of Zone Selection







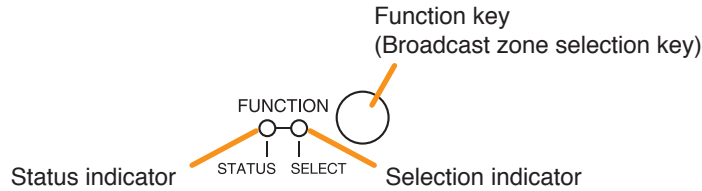

When a zone selection (pattern or individual) function has been assigned to a function key, the 2 indicators to the left of the key indicate its zone selection and broadcast status.

Note

For instructions on assigning functions to function keys, see the separate Setting Software Instructions, "EVENT SETTINGS."



Indicator meanings are as follows:

Indicator	Status	Meaning
Selection indicator	Unlit 	No zone selected
	Lights green 	Zone selected
Status indicator	Unlit 	Zones assigned to this Broadcast Zone Selection key not in use or BGM broadcast in progress
	Flashes green 	A part of zones or the entire zone assigned to this Broadcast Zone Selection key is occupied by a broadcast from another device (secondary Remote Microphone or general EV message).
	Flashes yellow 	All the zones assigned to this Broadcast Zone Selection key are engaged by a broadcast from the Secondary Emergency Remote Microphone.
	Lights red 	All the zones assigned to this Broadcast Zone Selection key are engaged by an evacuation message.
	Flashes red 	All the zones assigned to this Broadcast Zone Selection key are engaged by an alert message.
	Lights green 	All the zones assigned to this Broadcast Zone Selection key are engaged by a restoration message.

1.4. Indicator State at the Time of Base Pattern Change



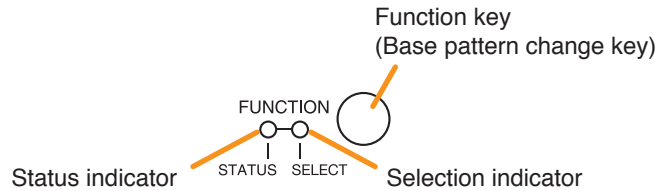

When a Base pattern change function has been assigned to a function key, the 2 indicators to the left of the key indicate its pattern selection and broadcast status.

Note

For instructions on assigning functions to function keys, see the separate Setting Software Instructions, "EVENT SETTINGS."



Indicator meanings are as follows:

Indicator	Status	Meaning
Selection indicator	Unlit 	When the function key is not pressed
	Lights green 	When the function key is pressed (Lights briefly, then goes off)
Status indicator	Unlit 	When the Base pattern assigned to the function key is not being broadcast
	Lights yellow 	When the Base pattern assigned to the function key is being broadcast (including broadcasts activated by other devices)

1.5. Indicator State at the Time of General-Purpose Broadcast Pattern



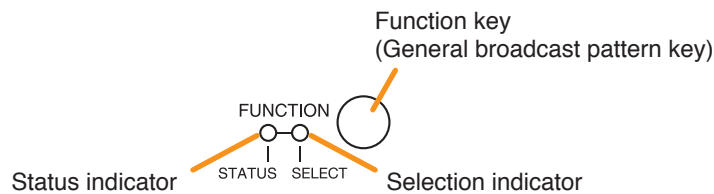

When a general-purpose broadcast pattern function has been assigned to a function key, the 2 indicators to the left of the key indicate its pattern selection and broadcast status.

Note

For instructions on assigning functions to function keys, see the separate Setting Software Instructions, "EVENT SETTINGS."



Indicator meanings are as follows:

Indicator	Status	Meaning
Selection indicator	Unlit 	When the function key is not pressed
	Lights green 	When the function key is pressed
Status indicator	Unlit 	When the broadcast pattern assigned to the function key is not being broadcast
	Flashes yellow 	When the broadcast pattern assigned to the function key is being broadcast

1.6. Indicator State at the Time of General/BGM Broadcast



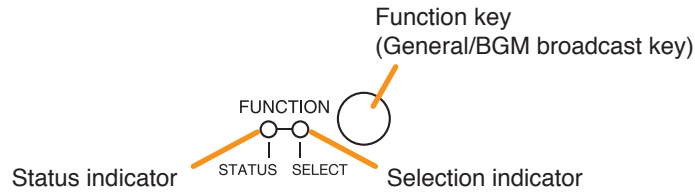

When a general/BGM broadcast function has been assigned to a function key, the 2 indicators to the left of the key indicate its selection and broadcast status.

Note

For instructions on assigning functions to function keys, see the separate Setting Software Instructions, "EVENT SETTINGS."



Indicator meanings are as follows:

Indicator	Status	Meaning
Selection indicator	Unlit 	When the function key is not pressed
	Lights green 	When the unit is brought in general/BGM broadcast by pressing the function key
Status indicator	Unlit 	When a general/BGM broadcast assigned to the function key is not activated
	Lights green 	When the audio source for a general/BGM broadcast assigned to the function key is being broadcast to the zones other than those selected by this unit.
	Lights yellow 	When the audio source for a general/BGM broadcast assigned to the function key is being broadcast to at least one of the zones selected by this unit.

1.7. Indicator State at the Time of Intended Control Input

When an intended control input function has been assigned to a function key, the 2 indicators to the left of the key indicate its selection and control status.

Note

Operation may become invalid even if you press the function key when the status indicator is lighting. This is such a case when the control input is placed in Active state by other device. Wait until the status indicator goes off, then press the function key again. Function key operation is always active as long as the status indicator is unlit.

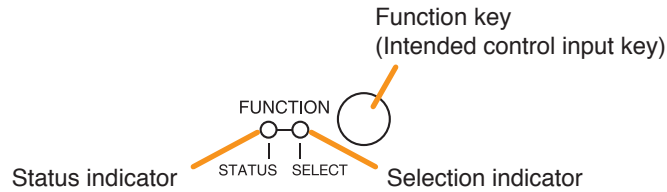

Indicator meanings are as follows:

Indicator	Status	Meaning
Selection indicator	Unlit	When the function key is not pressed
	Lights green	When the function key is pressed
Status indicator	Unlit	When the control input assigned to this function key is in Inactive* state
	Lights yellow	When the control input assigned to this function key is in Active* state

* When the control input polarity is set to "NO" in the Event setting, the function key becomes Active while the control input is closed, and becomes Inactive when it is open. Conversely, when the polarity is set to "NC," the function key becomes Active while the control input is open, and becomes Inactive when it is closed.

1.8. Indicator State at the Time of Intended Control Output (Pulse)



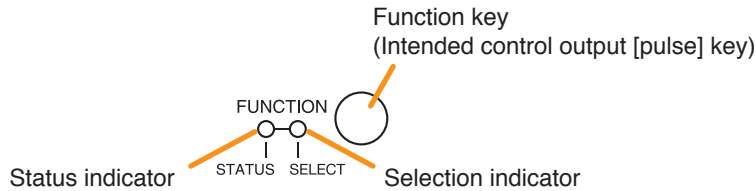

When the intended control output (pulse) function is assigned to the function key, pressing this key turns ON the preset control output. It is turned OFF when this key is pressed again.
 When an intended control output (pulse) function has been assigned to a function key, the 2 indicators to the left of the key indicate its selection and control statuses.

Note

Operation may become invalid even if you press the function key when the status indicator is lighting. This is such a case when the Control output pattern is being activated by other Event. Wait until the status indicator goes off, then press the function key again. Function key operation is always active as long as the status indicator is unlit.



Indicator meanings are as follows:

Indicator	Status	Meaning
Selection indicator	Unlit 	When the function key is not pressed
	Lights green 	When the function key is pressed
Status indicator	Unlit 	When the Control output pattern assigned to this function key is not activated
	Lights yellow 	When the Control output pattern assigned to this function key is being activated

1.9. Indicator State at the Time of Intended Control Output (Level)



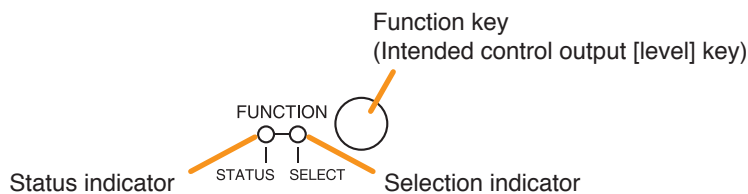

When the intended control output (level) function is assigned to the function key, the preset control output is turned ON while this key is held down. It is turned OFF when this key is released.
 When an intended control output (level) function has been assigned to a function key, the 2 indicators to the left of the key indicate its selection and control statuses.

Note

Operation may become invalid even if you press the function key when the status indicator is lighting. This is such a case when the Control output pattern is being activated by other Event. Wait until the status indicator goes off, then press the function key again. Function key operation is always active as long as the status indicator is unlit.



Indicator meanings are as follows:

Indicator	Status	Meaning
Selection indicator	Unlit 	When the function key is not pressed
	Lights green 	When the function key is pressed (as long as it is pressed)
Status indicator	Unlit 	When the Control output pattern assigned to this function key is not activated
	Lights yellow 	When the Control output pattern assigned to this function key is being activated

1.10. Indicator State at the Time of Zone Volume Adjustment (Pulse)



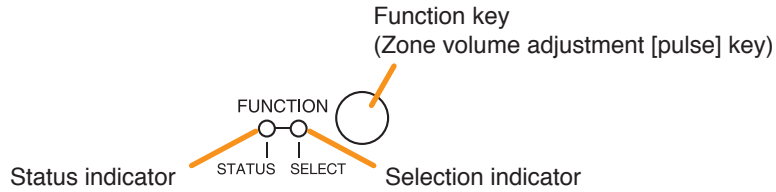

When the Zone volume adjustment (Pulse) function is assigned to the function key, pressing this key increases or decreases the volume level of the preset zone by the set amount. Sound adjustment status can be checked by the indicators to the left of the function key.

Note

For instructions on assigning functions to function keys, see the separate Setting Software Instructions, "EVENT SETTINGS."



Indicator meanings are as follows:

Indicator	Status	Meaning
Selection indicator	Unlit 	When the function key is not pressed
	Lights green 	When the function key is pressed (as long as it is pressed)
Status indicator	Unlit 	In the case the set value* ¹ of the volume adjustment is positive (volume increase): When the current volume adjustment value of the zone assigned to this key is less than the initial value* ² In the case the set value* ¹ of the volume adjustment is negative (volume decrease): When the current volume adjustment value of the zone assigned to this key is greater than the initial value* ²
	Lights green 	In the case the set value* ¹ of the volume adjustment is positive (volume increase): When the current volume adjustment value of the zone assigned to this key is greater than the initial value* ² In the case the set value* ¹ of the volume adjustment is negative (volume decrease): When the current volume adjustment value of the zone assigned to this key is less than the initial value* ²

*¹ Value set in "Event setting" of the VX-3000 Setting Software.

*² Volume set in "Sound settings (output)" of the VX-3000 Setting Software.

1.11. Indicator State at the Time of Input Volume Adjustment (Pulse)



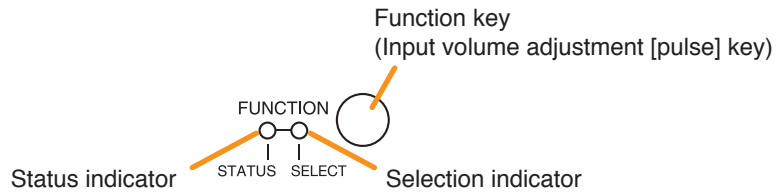

When the Input volume adjustment (Pulse) function is assigned to the function key, pressing this key increases or decreases the volume level of the preset Input channel by the set amount. Sound adjustment status can be checked by the indicators to the left of the function key.

Note

For instructions on assigning functions to function keys, see the separate Setting Software Instructions, "EVENT SETTINGS."



Indicator meanings are as follows:

Indicator	Status	Meaning
Selection indicator	Unlit 	When the function key is not pressed
	Lights green 	When the function key is pressed (as long as it is pressed)
Status indicator	Unlit 	In the case the set value* ¹ of the volume adjustment is positive (volume increase): When the current volume adjustment value of the input channel assigned to this key is less than the initial value* ² In the case the set value* ¹ of the volume adjustment is negative (volume decrease): When the current volume adjustment value of the input channel assigned to this key is greater than the initial value* ²
	Lights green 	In the case the set value* ¹ of the volume adjustment is positive (volume increase): When the current volume adjustment value of the input channel assigned to this key is greater than the initial value* ² In the case the set value* ¹ of the volume adjustment is negative (volume decrease): When the current volume adjustment value of the input channel assigned to this key is less than the initial value* ²

*¹ Value set in "Event setting" of the VX-3000 Setting Software.

*² Volume set in "Sound settings (input)" of the VX-3000 Setting Software.

1.12. Indicator State at the Time of Emergency Warning Broadcast

The emergency warning broadcast function can be assigned to the function key.

Pressing this key activates the emergency warning broadcast.



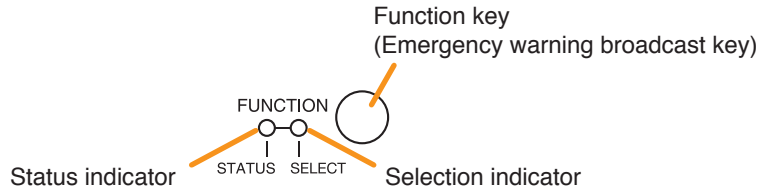

When this function has been assigned to a function key, the 2 indicators to the left of the key indicate its selection and broadcast status.

Note

For instructions on assigning functions to the function keys, see the separate Setting Software Instructions, "EVENT SETTINGS."



Indicator meanings are as follows:

Indicator	Status	Meaning
Selection indicator	Unlit 	When the function key is not pressed
	Lights green 	When the function key is pressed
Status indicator	Unlit 	When the audio source for an emergency warning broadcast assigned to the function key is not broadcast to any zones
	Lights green 	When the audio source for an emergency warning broadcast assigned to the function key is broadcast to the zones other than those assigned to this key
	Lights yellow 	When the audio source for an emergency warning broadcast assigned to the function key is broadcast to at least a part of the zones assigned to this key

1.13. Indicator State at the Time of Sleep Mode Power On

When the VX-3000 system is set to enable "Sleep mode function," the power on function can be assigned to a function key.

Pressing the key to which this function is assigned while in sleep mode turns the amplifier's power ON, and pressing it when the amplifier's power is ON switches to the sleep mode.

Notes

- For instructions on setting sleep mode function, see the separate Setting Software Instructions, "BASIC SETTINGS."
- For instructions on assigning functions to the function keys, see the separate Setting Software Instructions, "EVENT SETTINGS."

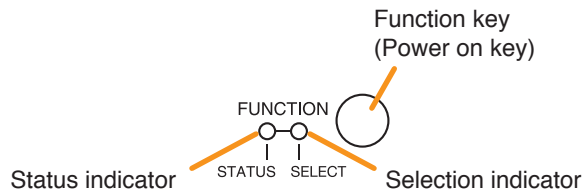

Indicator meanings are as follows:

Indicator	Status	Meaning
Selection indicator	Unlit	Amplifier's power is OFF, or it is placed in ON by another function.
	Lights green	Amplifier's power is placed in ON by pressing this function key.
Status indicator	Unlit	Amplifier's power is OFF, or it is placed in ON through this function key operation.
	Lights green	Amplifier's power is placed in ON by another function.

2. RM-200SF FIREMAN'S MICROPHONE AND RM-320F REMOTE MICROPHONE EXTENSION

2.1. Indicator State at the Time of Zone Selection







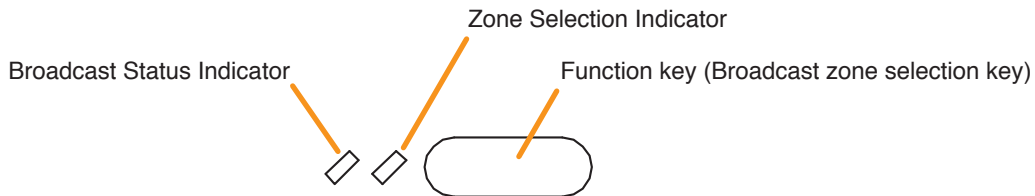

When a zone selection (pattern or individual) function has been assigned to a function key, the 2 indicators to the left of the key indicate its zone selection and broadcast status.

Note

For instructions on assigning functions to function keys, see the separate Setting Software Instructions, "EVENT SETTINGS."







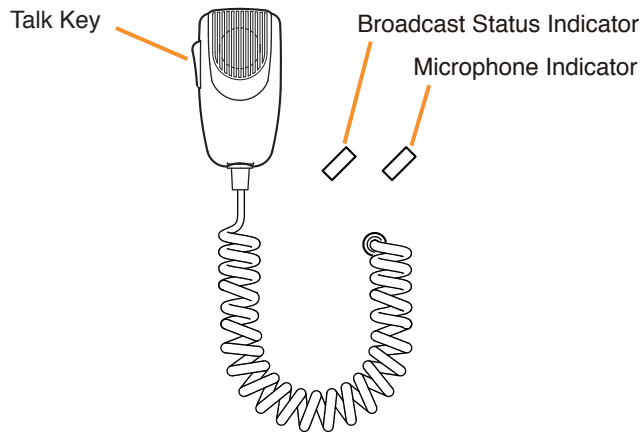

Indicator meanings are as follows:

Indicator	Status	Meaning
Zone Selection Indicator	Unlit 	No zone selected
	Lights green 	Zone selected
Broadcast Status Indicator	Unlit 	Zones assigned to this Broadcast Zone Selection key not in use or BGM broadcast in progress
	Flashes green 	A part of zones or the entire zone assigned to this Broadcast Zone Selection key is occupied by a broadcast from another device (secondary Remote Microphone or general EV message), or a part of zones is engaged by a broadcast from the primary Remote Microphone (RM-200SF).
	Lights yellow 	All the zones selected by this Broadcast Zone Selection key on the primary Remote Microphone are engaged by a broadcast from the primary Remote Microphone.
	Flashes yellow 	All the zones assigned to this Broadcast Zone Selection key are engaged by a broadcast from the Secondary Emergency Remote Microphone.
	Lights red 	All the zones assigned to this Broadcast Zone Selection key are engaged by an evacuation message.
	Flashes red 	All the zones assigned to this Broadcast Zone Selection key are engaged by an alert message.
	Lights green 	All the zones assigned to this Broadcast Zone Selection key are engaged by a restoration message.

2.2. Talk Key Indicators



Indicator meanings are as follows:

Indicator	Status	Meaning
Microphone Indicator	Unlit 	Microphone not in use
	Lights green 	Microphone in use
	Flashes green 	Chime broadcast in progress from the primary Remote Microphone.
Broadcast Status Indicator	Unlit 	Zone not in use (microphone announcement possible)
	Flashes green 	A part of zones or the entire zone selected by the primary Remote Microphone is occupied by a broadcast from another device (secondary Remote Microphone, chime, etc.), or a broadcast from the primary Remote Microphone is in progress in a part of the zones selected by the primary Remote Microphone.
	Lights yellow 	All zones selected by the primary Remote Microphone are engaged by a broadcast from the primary Remote Microphone.

2.3. Indicator State at the Time of Base Pattern Change



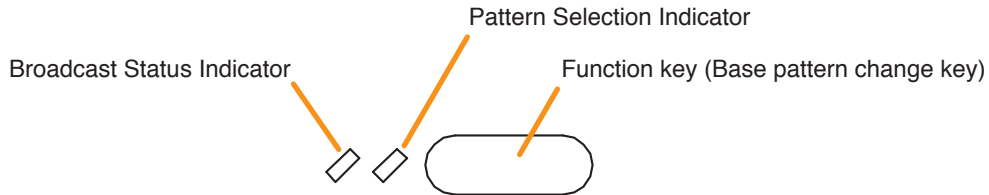

When a Base pattern change function has been assigned to a function key, the 2 indicators to the left of the key indicate its pattern selection and broadcast status.

Note

For instructions on assigning functions to function keys, see the separate Setting Software Instructions, "EVENT SETTINGS."



Indicator meanings are as follows:

Indicator	Status	Meaning
Pattern Selection Indicator	Unlit 	When the function key is not pressed
	Lights green 	When the function key is pressed (Lights briefly, then goes off)
Broadcast Status Indicator	Unlit 	When the Base pattern assigned to the function key is not being broadcast
	Lights yellow 	When the Base pattern assigned to the function key is being broadcast (including broadcasts activated by other devices)

2.4. Indicator State at the Time of General-Purpose Broadcast Pattern



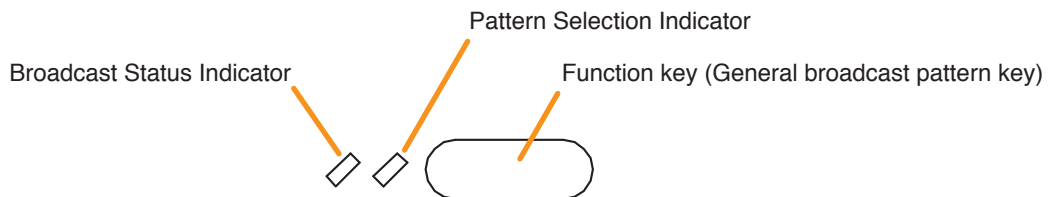

When a general-purpose broadcast pattern function has been assigned to a function key, the 2 indicators to the left of the key indicate its pattern selection and broadcast status.

Note

For instructions on assigning functions to function keys, see the separate Setting Software Instructions, "EVENT SETTINGS."



Indicator meanings are as follows:

Indicator	Status	Meaning
Pattern Selection Indicator	Unlit 	When the function key is not pressed
	Lights green 	When the function key is pressed
Broadcast Status Indicator	Unlit 	When the broadcast pattern assigned to the function key is not being broadcast
	Flashes yellow 	When the broadcast pattern assigned to the function key is being broadcast

2.5. Indicator State at the Time of General/BGM Broadcast



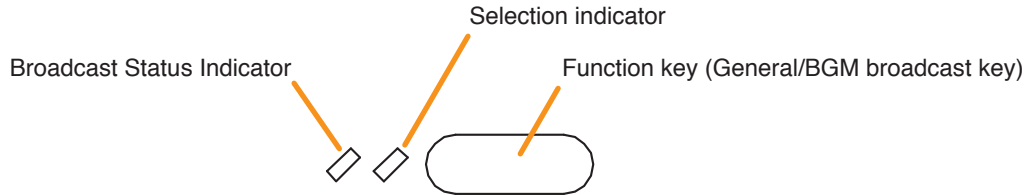

When a general/BGM broadcast function has been assigned to a function key, the 2 indicators to the left of the key indicate its selection and broadcast status.

Note

For instructions on assigning functions to function keys, see the separate Setting Software Instructions, "EVENT SETTINGS."



Indicator meanings are as follows:

Indicator	Status	Meaning
Selection Indicator	Unlit 	When the function key is not pressed
	Lights green 	When the unit is brought in general/BGM broadcast by pressing the function key
Broadcast Status Indicator	Unlit 	When a general/BGM broadcast assigned to the function key is not activated
	Lights green 	When the audio source for a general/BGM broadcast assigned to the function key is being broadcast to the zones other than those selected by this unit.
	Lights yellow 	When the audio source for a general/BGM broadcast assigned to the function key is being broadcast to at least one of the zones selected by this unit.

2.6. Indicator State at the Time of RM Broadcast Status Display



The Broadcast status indicator to the left of the Function key indicates the current broadcast status of other Remote Microphone.

Note

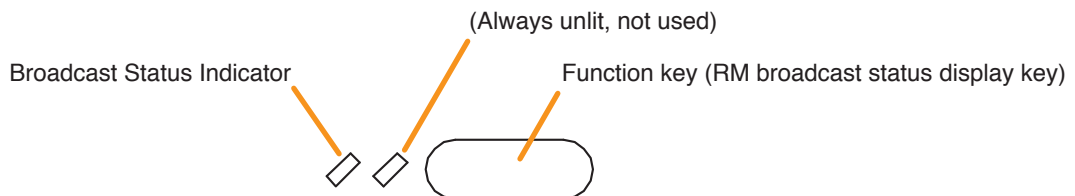
For instructions on assigning functions to function keys, see the separate Setting Software Instructions, "EVENT SETTINGS."



Indicator meanings are as follows:

Indicator	Status	Meaning
Broadcast Status Indicator	Unlit 	When the Remote Microphone assigned to the function key is not engaged in broadcasting
	Lights yellow 	When the Remote Microphone assigned to the function key is engaged in broadcasting

2.7. Indicator State at the Time of Lamp Test



When the lamp test function has been assigned to the Function key, the 2 indicators to the left of the key indicate the running status of the lamp test. Pressing the Lamp test key causes all indicators on the primary Remote Microphone to light, and the built-in buzzer to sound.

Note

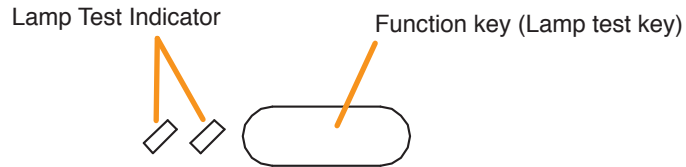
For instructions on assigning functions to function keys, see the separate Setting Software Instructions, "EVENT SETTINGS."



Indicator meanings are as follows:

Indicator	Status	Meaning
Lamp Test Indicator	Unlit 	When the function key is not pressed
	Lights yellow and green 	Lamp test has been executed by pressing the function key.

2.8. Indicator State at the Time of Failure Output Receipt

When the VX-3000 system is set to enable "Surveillance function," the failure output receipt function can be assigned to a function key.



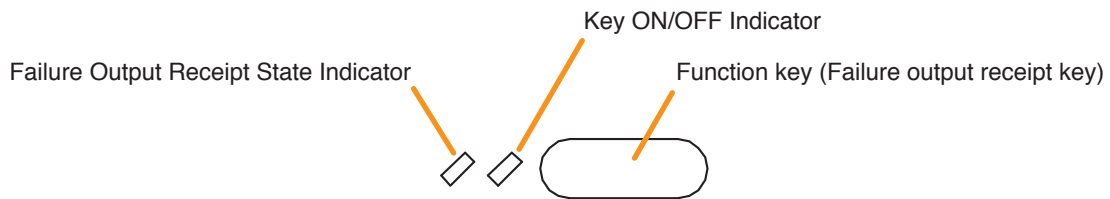

When the failure output receipt function has been assigned to the Function key, the 2 indicators to the left of the key indicate the occurrence and acknowledgement status of the failure output pattern.

Notes

- For instructions on setting the surveillance function, see the separate Setting Software Instructions, "BASIC SETTINGS."
- For instructions on assigning functions to function keys, see the separate Setting Software Instructions, "EVENT SETTINGS."



Indicator meanings are as follows:

Indicator	Status	Meaning
Key ON/OFF Indicator	Unlit 	When the function key is not pressed
	Lights green 	When the function key is pressed (as long as it is pressed)
Failure Output Receipt State Indicator	Flashes yellow 	When the failure output pattern assigned to the function key has occurred.
	Lights yellow 	Failure Output Pattern has been acknowledged after pressing the function key.

2.9. Indicator State at the Time of Failure Output Reset

When the VX-3000 system is set to enable "Surveillance function," the failure output reset function can be assigned to a function key.



When the failure output reset function has been assigned to the Function key, the failure status indicator can be reset by pressing the key. The indicator to the left of the key lights only when the key is pressed.

Notes

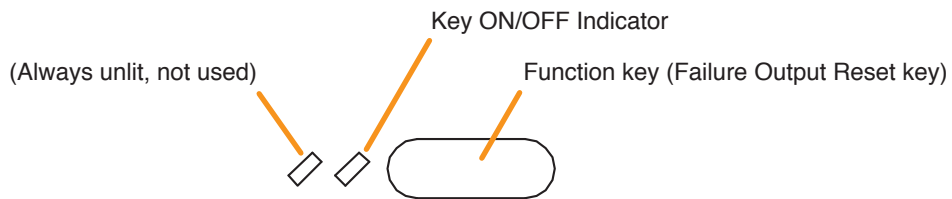
- For instructions on setting surveillance function, see the separate Setting Software Instructions, "BASIC SETTINGS."
- For instructions on assigning functions to function keys, see the separate Setting Software Instructions, "EVENT SETTINGS."



Indicator meanings are as follows:

Indicator	Status	Meaning
Key ON/OFF Indicator	Unlit 	When the function key is not pressed
	Lights green 	When the function key is pressed (as long as it is pressed)

2.10. Indicator State at the Time of Emergency Broadcast Pattern Start

When the system is set to "Emergency," the emergency broadcast pattern start function can be assigned to the Emergency key or function key.

Pressing the function-assigned key causes the emergency broadcast to start.

Assigning this function to the Emergency key causes the key to light or go off, indicating the emergency state of the VX-3000 system.

Meanwhile, when a function key is assigned this function, the 2 indicators next to the key indicate the emergency start and emergency states of the VX-3000 system.



Notes

- For the emergency function settings, see the separate Setting Software Instructions, "BASIC SETTINGS."
- For instructions on assigning functions to the emergency key and function keys, see the separate Setting Software Instructions, "EVENT SETTINGS."

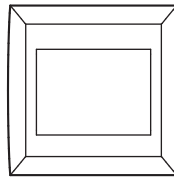
[When assigned to the Emergency key]





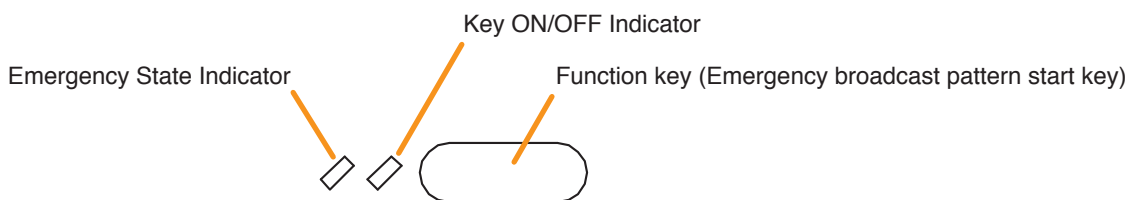

Emergency key

Indicator	Status	Meaning
Emergency Key Indicator	Unlit 	The VX-3000 system is not in an emergency condition.
	Lights red 	The Emergency Broadcast Pattern is started by pressing this Emergency key or the VX-3000 system is in an emergency condition.

[When assigned to the function key]



Indicator meanings are as follows:

Indicator	Status	Meaning
Key ON/OFF Indicator	Unlit 	When the function key is not pressed
	Lights green 	When the function key is pressed (as long as it is pressed)
Emergency State Indicator	Unlit 	Emergency Broadcast Patterns assigned to the function key are not broadcast.
	Flashes red 	A part of Emergency Broadcast Patterns assigned to the function key is broadcast.
	Lights red 	All Emergency Broadcast Patterns assigned to the function key are broadcast.

2.11. Indicator State at the Time of Emergency Broadcast Pattern Stop

When the system is set to "Emergency," the emergency broadcast pattern stop function can be assigned to the Function key.



Pressing the function-assigned key causes the emergency broadcast pattern to stop. The indicator to the left of the key lights only when the key is pressed.

Notes

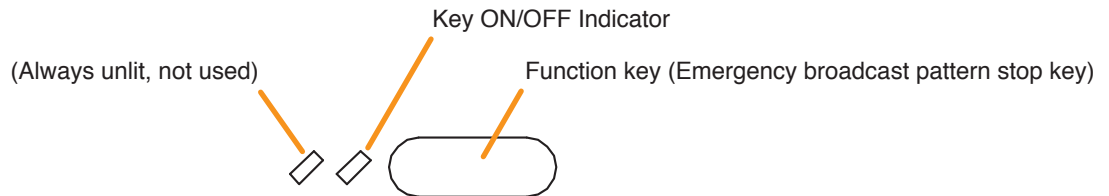
- For the emergency function settings, see the separate Setting Software Instructions, "BASIC SETTINGS."
- For instructions on assigning functions to the function keys, see the separate Setting Software Instructions, "EVENT SETTINGS."



Indicator meanings are as follows:

Indicator	Status	Meaning
Key ON/OFF Indicator	Unlit 	When the function key is not pressed
	Lights green 	When the function key is pressed (as long as it is pressed)

2.12. Indicator State at the Time of Emergency Broadcast Pattern Start/Stop

When the system is set to "Emergency," the emergency broadcast pattern start function can be assigned to the Emergency key or function key.

When the Emergency Broadcast Pattern set to the function-assigned key is OFF, pressing this key activates the emergency broadcast.

When the Emergency Broadcast Pattern set to the function-assigned key is ON, pressing this key stops the corresponding emergency broadcast pattern or returns the emergency mode to the normal state. The selection of which operation to perform depends on the setting.

Assigning this function to the Emergency key causes the key to light or go off, indicating the emergency state of the VX-3000 system.

Meanwhile, when a function key is assigned this function, the 2 indicators next to the key indicate the emergency start and emergency states of the VX-3000 system.



Notes

- For the emergency function settings, see the separate Setting Software Instructions, "BASIC SETTINGS."
- For instructions on assigning functions to the Emergency key and function keys, see the separate Setting Software Instructions, "EVENT SETTINGS."

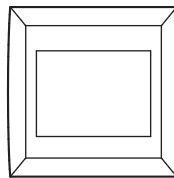
[When assigned to the Emergency key]





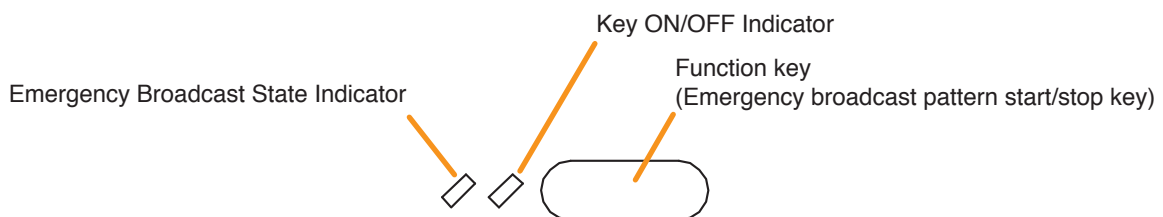

Emergency key

Indicator	Status	Meaning
Emergency Key Indicator	Unlit 	The VX-3000 system is not in an emergency condition.
	Lights red 	The Emergency Broadcast Pattern is started by pressing this Emergency key or the VX-3000 system is in an emergency condition.

[When assigned to the function key]



Indicator meanings are as follows:

Indicator	Status	Meaning
Key ON/OFF Indicator	Unlit 	When the function key is not pressed
	Lights green 	When the function key is pressed (as long as it is pressed)
Emergency Broadcast State Indicator	Unlit 	Emergency Broadcast Pattern assigned to the function key is not broadcast.
	Lights green 	Restoration Message broadcast assigned to the function key is being activated.
	Lights red 	Emergency Broadcast Pattern assigned to the function key is broadcast.

2.13. Indicator State at the Time of Emergency Sequence Stop

When the system is set to "Emergency," the emergency sequence stop function can be assigned to the Function key.



Pressing the function-assigned key causes all the emergency broadcast patterns including the set emergency sequence to stop. The indicator to the left of the key lights only when the key is pressed.

Notes

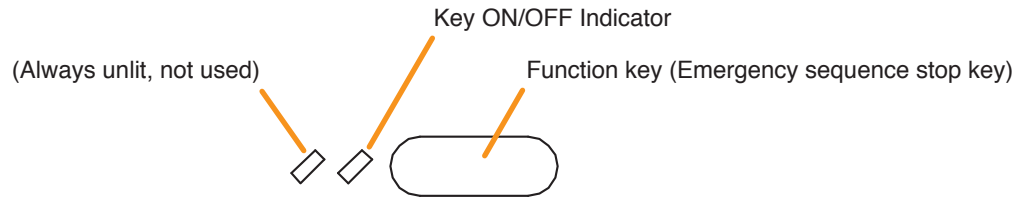
- For the emergency function settings, see the separate Setting Software Instructions, "BASIC SETTINGS."
- For instructions on assigning functions to the function keys, see the separate Setting Software Instructions, "EVENT SETTINGS."



Indicator meanings are as follows:

Indicator	Status	Meaning
Key ON/OFF Indicator	Unlit 	When the function key is not pressed
	Lights green 	When the function key is pressed (as long as it is pressed)

2.14. Indicator State at the Time of Emergency Sequence Phase Shift

When the system is set to "Emergency," the emergency sequence phase shift function can be assigned to a function key.

Pressing the function-assigned key causes the set emergency sequence to shift to the next phase.



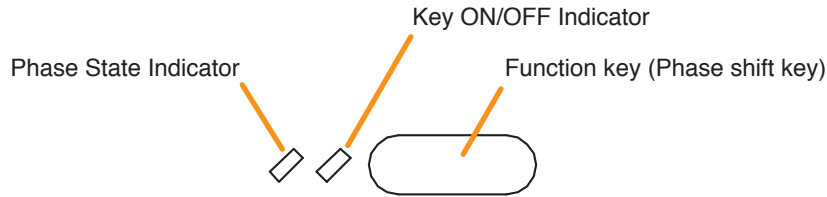

The 2 indicators next to the Function key indicate the emergency sequence phase state.

Notes

- For the emergency function settings, see the separate Setting Software Instructions, "BASIC SETTINGS."
- For instructions on assigning functions to function keys, see the separate Setting Software Instructions, "EVENT SETTINGS."



Indicator meanings are as follows:

Indicator	Status	Meaning
Key ON/OFF Indicator	Unlit 	When the function key is not pressed
	Lights green 	When the function key is pressed (as long as it is pressed)
Phase State Indicator	Lights green 	Emergency sequence assigned to the function key is in Phase 1.
	Flashes green 	Emergency sequence assigned to the function key is in Phase 2.
	Unlit 	Emergency sequence assigned to the function key is in Phase 3.

2.15. Indicator State at the Time of Emergency Reset



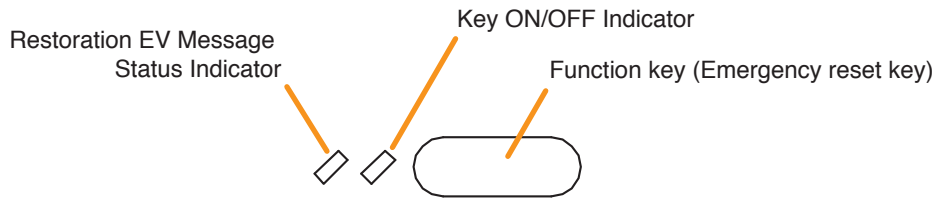

When the system is set to "Emergency," the emergency reset function can be assigned to the Function key. Pressing the function-assigned key causes all the activated emergency broadcast patterns to stop, allowing the emergency broadcast status to be reset after the restoration EV message broadcast completion. The 2 indicators next to the Function key indicate the emergency reset state.

Notes

- For the emergency function settings, see the separate Setting Software Instructions, "BASIC SETTINGS."
- For instructions on assigning functions to function keys, see the separate Setting Software Instructions, "EVENT SETTINGS."



Indicator meanings are as follows:

Indicator	Status	Meaning
Key ON/OFF Indicator	Unlit 	When the function key is not pressed
	Lights green 	When the function key is pressed (as long as it is pressed)
Restoration EV Message Status Indicator	Unlit 	Restoration EV Message broadcast assigned to the function key is being stopped.
	Lights green 	Restoration EV Message broadcast assigned to the function key is being activated.

2.16. Indicator State at the Time of Emergency Broadcast Silence

When the system is set to "Emergency," the emergency broadcast silence function can be assigned to the function key.

The emergency broadcast silence function is a function to mute the output of the EV sound sources of which audio source type is set to "Evacuate" or "Alert." Pressing the key to which this function is assigned once turns ON the function. Pressing it again turns OFF the function.



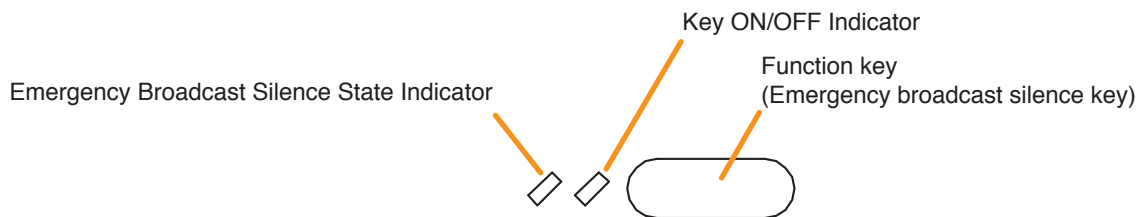

When this function has been assigned to the Function key, whether the emergency broadcast silence function is ON or OFF can be checked depending on the lighting statuses of the 2 indicators next to the Function key.

Notes

- For the emergency function settings, see the separate Setting Software Instructions, "BASIC SETTINGS."
- For instructions on assigning functions to the function key, see the separate Setting Software Instructions, "EVENT SETTINGS."
- The emergency broadcast silence function is valid only when the system is in the emergency mode.
- The emergency broadcast silence function changes to OFF if you reset the emergency mode while the emergency broadcast silence function remains ON.



Indicator meanings are as follows:

Indicator	Status	Meaning
Key ON/OFF Indicator	Unlit 	When the function key is not pressed
	Lights green 	When the function key is pressed (as long as it is pressed)
Emergency Broadcast Silence State Indicator	Unlit 	When the emergency broadcast silence function is not valid
	Flashes green 	When the emergency broadcast silence function is valid

2.17. Indicator State at the Time of Emergency EV Broadcast

When the system is set to "Emergency," the emergency EV broadcast function can be assigned to the Emergency key or function key.

Assigning the Emergency EV broadcast function to the key allows the EV sound source of which audio type is set to "Evacuate" or "Alert" only to be manually activated only while the system is in emergency mode.

When the Emergency EV broadcast function has been assigned to the Emergency key, its key's lighting status indicates the broadcast status.

When Emergency EV broadcast function has been assigned to a function key, the 2 indicators to the left of the key indicate its selection and broadcast statuses.



Notes

- For the emergency function settings, see the separate Setting Software Instructions, "BASIC SETTINGS."
- For instructions on assigning functions to the Emergency key and function keys, see the separate Setting Software Instructions, "EVENT SETTINGS."

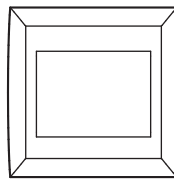
[When assigned to the Emergency key]





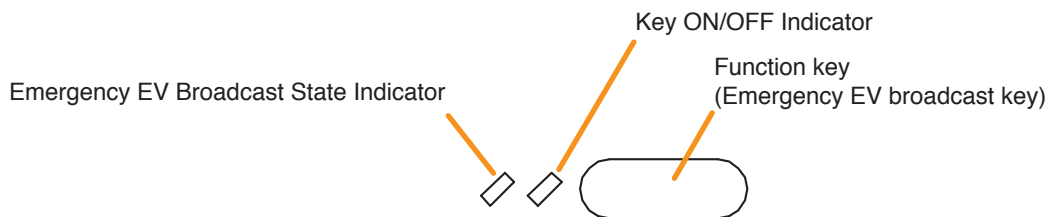

Emergency key

Indicator	Status	Meaning
Emergency Key Indicator	Unlit 	When the Emergency EV message assigned to the Emergency key is not broadcast to any zones
	Lights red 	When the Emergency EV message assigned to the Emergency key is broadcast to at least a part of the zones

[When assigned to the function key]



Indicator meanings are as follows:

Indicator	Status	Meaning
Key ON/OFF Indicator	Unlit 	When the function key is not pressed
	Lights green 	When the function key is pressed
Emergency EV Broadcast State Indicator	Unlit 	When the Emergency EV message assigned to the Emergency key is not broadcast to any zones
	Lights red 	When the Emergency EV message assigned to the Emergency key is broadcast to at least a part of the zones

2.18. Indicator State at the Time of Emergency Acknowledge

When the system is set to "Emergency," the Emergency acknowledge function can be assigned to the Emergency key or function key.

If the Emergency acknowledge function has been assigned to the key, the buzzer built in the remote microphone sounds when the emergency broadcast pattern assigned to this key turns ON. You can stop the buzzer sound by pressing the Emergency acknowledge function assigned key.

When the Emergency acknowledge function has been assigned to the Emergency key, its key's lighting status indicates the emergency broadcast activation and emergency acknowledge status.

When the Emergency acknowledge function has been assigned to the Function key, the 2 indicators next to the key indicate the emergency broadcast activation and emergency acknowledge status.



Notes

- For the emergency function settings, see the separate Setting Software Instructions, "BASIC SETTINGS."
- For instructions on assigning functions to the Emergency key and function keys, see the separate Setting Software Instructions, "EVENT SETTINGS."

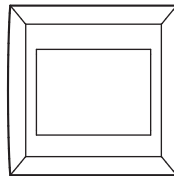
[When assigned to the Emergency key]



Emergency key



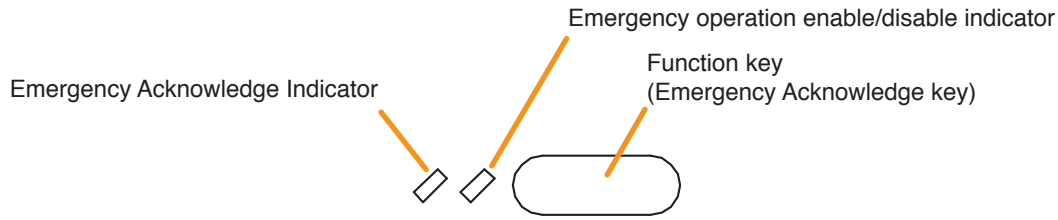

Indicator	Status	Meaning
Emergency Key Indicator	Unlit 	Emergency operation* from this remote microphone is disabled.
	Flashes red 	When the buzzer is sounding: Emergency acknowledge has not been received by this remote microphone and emergency operation* from this remote microphone is disabled. When the buzzer is not sounding: Emergency operation* from this remote microphone is enabled.
	Lights red 	When Emergency acknowledge has been received by this remote microphone and emergency operation* from this remote microphone is enabled.

* All operations related to the emergency broadcasts such as Emergency broadcast pattern start/stop, Emergency sequence phase shift, and Emergency reset.

[When assigned to the function key]



Indicator meanings are as follows:

Indicator	Status	Meaning
Emergency operation* ¹ enable/disable indicator	Unlit 	When set to EMG enable operation ON* ² : Emergency operation from this remote microphone is disabled. When set to EMG operation OFF* ³ (Constantly unlit)
	Lights green 	When set to EMG enable operation ON* ² : Emergency operation* ¹ from this remote microphone is enabled.
Emergency Acknowledge Indicator	Unlit 	When the system is not in emergency mode
	Flashes red 	When the system is in emergency mode and emergency acknowledge has not been received by this remote microphone.
	Lights red 	When the system is in emergency mode and emergency acknowledge has been received by this remote microphone.

*¹ All operations related to the emergency broadcasts such as Emergency broadcast pattern start/stop, Emergency sequence phase shift, and Emergency reset.
 *² It is so set by the VX-3000 Setting Software that Emergency operation cannot be performed until the emergency acknowledge key is pressed once the emergency broadcast pattern has been activated.
 *³ It is so set by the VX-3000 Setting Software that Emergency operation can be performed without pressing the emergency acknowledge key once the emergency broadcast pattern has been activated.

2.19. Indicator State at the Time of Disablement of EMG Control from CIN

When the system is set to "Emergency," the "disablement of EMG control from CIN" function can be assigned to the function key.

When this function is assigned to the function key, you can stop the emergency activation from the control input when the system is in general mode.

This function is intended not to activate the emergency broadcast by the fire alarm system during maintenance. When this function is assigned to 2 or more remote microphones, it can be made invalid only by performing cancellation operation at all these remote microphones.

When this function is assigned to the function key, the 2 indicators next to the key indicate the key selection status, enable/disable status of the function, and acknowledge status.

This function is enabled only when the system is in general mode. Even if you press the key to which this function is assigned while the system is in emergency mode, a beep tone will sound, making the operation invalid.



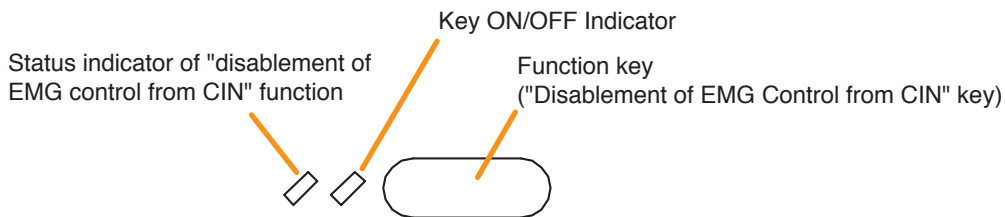

You can set a warning buzzer notifying that this function is being left ON. When this warning buzzer is set to ON, a beep tone will sound once every 10 seconds at the remote microphone where this function has been activated, indicating that the emergency activation from the control input is placed in invalid status. When this function is turned OFF at the remote microphone, the beep tone only at the operated remote microphone will stop.

Notes

- For the emergency function settings, see the separate Setting Software Instructions, "BASIC SETTINGS."
- For instructions on assigning functions to the function key, see the separate Setting Software Instructions, "EVENT SETTINGS."



Indicator meanings are as follows:

Indicator	Status	Meaning
Key ON/OFF Indicator	Unlit 	When the function key is not pressed
	Lights green 	When the function key is pressed
Status indicator of "disablement of EMG control from CIN" function	Unlit 	When the disablement function of emergency activation from the control input is set to OFF
	Flashes red 	When the disablement function of emergency activation from the control input is turned ON by other remote microphone
	Lights red 	When the disablement function of emergency activation from the control input is turned ON by this remote microphone or when the status that this function is turned ON by other remote microphone is acknowledged

2.20. Indicator State at the Time of Audio Monitor



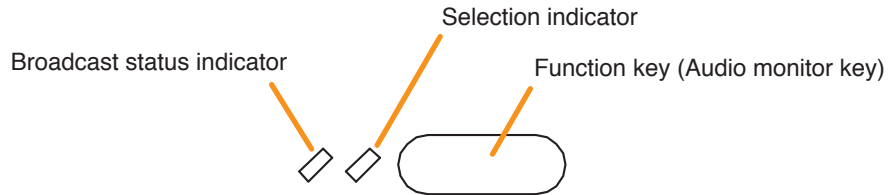

When an audio monitor function has been assigned to a function key, the 2 indicators to the left of the key indicate its selection and audio monitor status.

Notes

- Only one remote microphone can be used for audio monitoring even when 2 or more remote microphones are connected to a single VX-3000F.
Only the remote microphone of which Audio monitor key is pressed most recently is effective for audio monitoring, causing other remote microphone engaged in monitoring to be interrupted.
- For instructions on assigning functions to the function key, see the separate Setting Software Instructions, "EVENT SETTINGS."



Indicator meanings are as follows:

Indicator	Status	Meaning
Selection indicator	Unlit 	When the function key is not pressed
	Lights green 	When the function key is pressed
Broadcast status indicator	Unlit 	When no broadcast is made to the zone assigned to this function key
	Lights green 	When the function key is pressed while audio signals are being broadcast to the zone assigned to this function key

2.21. Indicator State at the Time of Intended Control Input



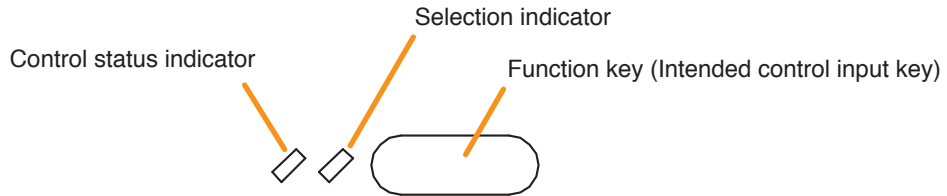

When an intended control input function has been assigned to a function key, the 2 indicators to the left of the key indicate its selection and control status.

Notes

- Operation may become invalid even if you press the function key when the Control status indicator is lighting. This is such a case when the control input is placed in Active state by other device. Wait until the Control status indicator goes off, then press the function key again. Function key operation is always active as long as the Control status indicator is unlit.
- For instructions on assigning functions to the function key, see the separate Setting Software Instructions, "EVENT SETTINGS."



Indicator meanings are as follows:

Indicator	Status	Meaning
Selection indicator	Unlit 	When the function key is not pressed
	Lights green 	When the function key is pressed
Control status indicator	Unlit 	When the control input assigned to this function key is in Inactive* state
	Lights yellow 	When the control input assigned to this function key is in Active* state

* When the control input polarity is set to "NO" in the Event setting, the function key becomes Active while the control input is closed, and becomes Inactive when it is open. Conversely, when the polarity is set to "NC," the function key becomes Active while the control input is open, and becomes Inactive when it is closed.

2.22. Indicator State at the Time of Intended Control Output (Pulse)

When the intended control output (pulse) function is assigned to the function key, pressing this key turns ON the preset control output. It is turned OFF when this key is pressed again.



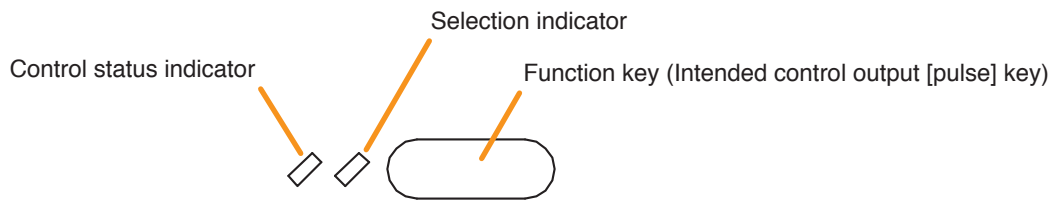

When an intended control output (pulse) function has been assigned to a function key, the 2 indicators to the left of the key indicate its selection and control statuses.

Notes

- Operation may become invalid even if you press the function key when the Control status indicator is lighting. This is such a case when the Control output pattern is being activated by other Event. Wait until the Control status indicator goes off, then press the function key again. Function key operation is always active as long as the Control status indicator is unlit.
- For instructions on assigning functions to the function key, see the separate Setting Software Instructions, "EVENT SETTINGS."



Indicator meanings are as follows:

Indicator	Status	Meaning
Selection indicator	Unlit 	When the function key is not pressed
	Lights green 	When the function key is pressed
Control status indicator	Unlit 	When the Control output pattern assigned to this function key is not activated
	Lights yellow 	When the Control output pattern assigned to this function key is being activated

2.23. Indicator State at the Time of Intended Control Output (Level)

When the intended control output (level) function is assigned to the function key, the preset control output is turned ON while this key is held down. It is turned OFF when this key is released.



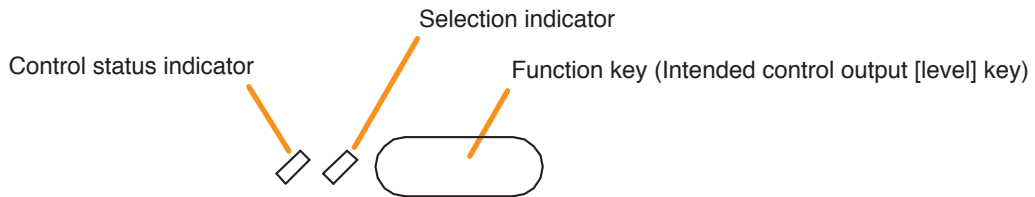

When an intended control output (level) function has been assigned to a function key, the 2 indicators to the left of the key indicate its selection and control statuses.

Notes

- Operation may become invalid even if you press the function key when the Control status indicator is lighting. This is such a case when the Control output pattern is being activated by other Event. Wait until the Control status indicator goes off, then press the function key again. Function key operation is always active as long as the Control status indicator is unlit.
- For instructions on assigning functions to the function key, see the separate Setting Software Instructions, "EVENT SETTINGS."



Indicator meanings are as follows:

Indicator	Status	Meaning
Selection indicator	Unlit 	When the function key is not pressed
	Lights green 	When the function key is pressed (as long as it is pressed)
Control status indicator	Unlit 	When the Control output pattern assigned to this function key is not activated
	Lights yellow 	When the Control output pattern assigned to this function key is being activated

2.24. Indicator State at the Time of Zone Volume Adjustment (Pulse)



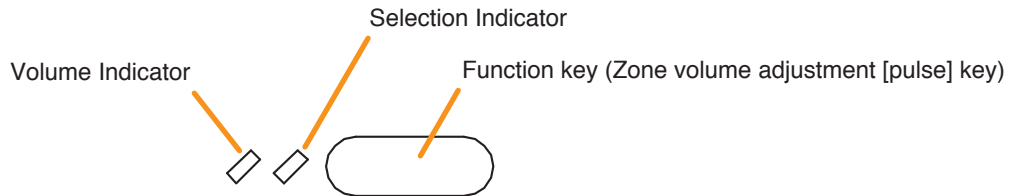

When the Zone volume adjustment (Pulse) function is assigned to the function key, pressing this key increases or decreases the volume level of the preset zone by the set amount. Sound adjustment status can be checked by the indicators to the left of the function key.

Note

For instructions on assigning functions to function keys, see the separate Setting Software Instructions, "EVENT SETTINGS."



Indicator meanings are as follows:

Indicator	Status	Meaning
Selection indicator	Unlit 	When the function key is not pressed
	Lights green 	When the function key is pressed (as long as it is pressed)
Volume Indicator	Unlit 	In the case the set value ^{*1} of the volume adjustment is positive (volume increase): When the current volume adjustment value of the zone assigned to this key is the initial value ^{*2} or less In the case the set value ^{*1} of the volume adjustment is negative (volume decrease): When the current volume adjustment value of the zone assigned to this key is the initial value ^{*2} or greater
	Lights green 	In the case the set value ^{*1} of the volume adjustment is positive (volume increase): When the current volume adjustment value of the zone assigned to this key is greater than the initial value ^{*2} In the case the set value ^{*1} of the volume adjustment is negative (volume decrease): When the current volume adjustment value of the zone assigned to this key is less than the initial value ^{*2}

*1 Value set in "Event setting" of the VX-3000 Setting Software.

*2 Volume set in "Sound settings (output)" of the VX-3000 Setting Software.

2.25. Indicator State at the Time of Input Volume Adjustment (Pulse)



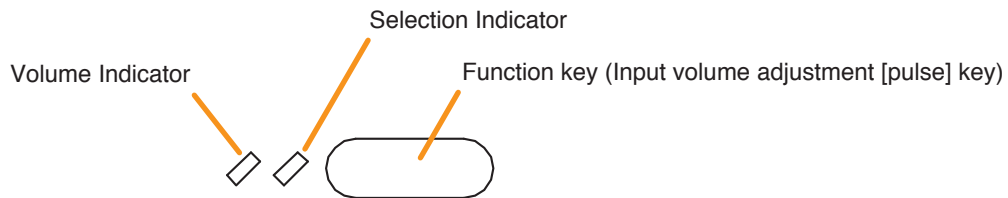

When the Input volume adjustment (Pulse) function is assigned to the function key, pressing this key increases or decreases the volume level of the preset Input channel by the set amount. Sound adjustment status can be checked by the indicators to the left of the function key.

Note

For instructions on assigning functions to function keys, see the separate Setting Software Instructions, "EVENT SETTINGS."



Indicator meanings are as follows:

Indicator	Status	Meaning
Selection indicator	Unlit 	When the function key is not pressed
	Lights green 	When the function key is pressed (as long as it is pressed)
Volume Indicator	Unlit 	In the case the set value ^{*1} of the volume adjustment is positive (volume increase): When the current volume adjustment value of the input channel assigned to this key is the initial value ^{*2} or less In the case the set value ^{*1} of the volume adjustment is negative (volume decrease): When the current volume adjustment value of the input channel assigned to this key is the initial value ^{*2} or greater
	Lights green 	In the case the set value ^{*1} of the volume adjustment is positive (volume increase): When the current volume adjustment value of the input channel assigned to this key is greater than the initial value ^{*2} In the case the set value ^{*1} of the volume adjustment is negative (volume decrease): When the current volume adjustment value of the input channel assigned to this key is less than the initial value ^{*2}

*1 Value set in "Event setting" of the VX-3000 Setting Software.

*2 Volume set in "Sound settings (input)" of the VX-3000 Setting Software.

2.26. Indicator State at the Time of Emergency Warning Broadcast

The emergency warning broadcast function can be assigned to the Emergency key or function key. Pressing this key activates the emergency warning broadcast.

When the Emergency key is assigned this function, the key indicate its broadcast status.

Meanwhile, when this function has been assigned to a function key, the 2 indicators to the left of the key indicate its selection and broadcast status.



Note

For instructions on assigning functions to the Emergency key and function keys, see the separate Setting Software Instructions, "EVENT SETTINGS."

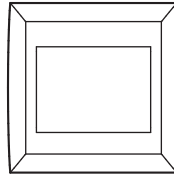
[When assigned to the Emergency key]





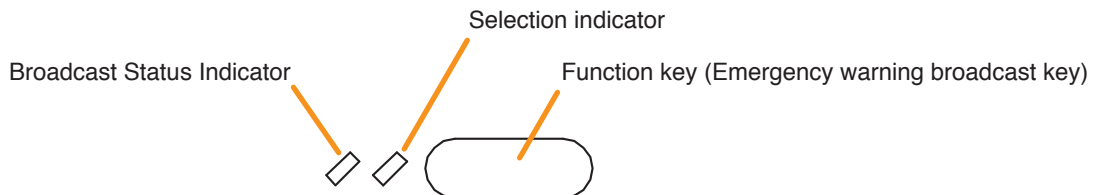

Emergency key

Indicator	Status	Meaning
Emergency Key Indicator	Unlit 	When the audio source for an emergency warning broadcast assigned to the Emergency key is not broadcast to any zones
	Lights red 	When the audio source for an emergency warning broadcast assigned to the Emergency key is broadcast to at least a part of the zones assigned to this key

[When assigned to the function key]



Indicator meanings are as follows:

Indicator	Status	Meaning
Selection Indicator	Unlit 	When the function key is not pressed
	Lights green 	When the function key is pressed
Broadcast Status Indicator	Unlit 	When the audio source for an emergency warning broadcast assigned to the function key is not broadcast to any zones
	Lights green 	When the audio source for an emergency warning broadcast assigned to the function key is broadcast to the zones other than those assigned to this key
	Lights yellow 	When the audio source for an emergency warning broadcast assigned to the function key is broadcast to at least a part of the zones assigned to this key

2.27. Indicator State at the Time of Sleep Mode Power On

When the VX-3000 system is set to enable "Sleep mode function," the power on function can be assigned to a function key.



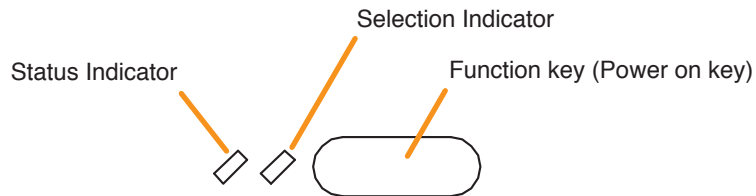

Pressing the key to which this function is assigned while in sleep mode turns the amplifier's power ON, and pressing it when the amplifier's power is ON switches to the sleep mode.

Notes

- For instructions on setting sleep mode function, see the separate Setting Software Instructions, "BASIC SETTINGS."
- For instructions on assigning functions to the function keys, see the separate Setting Software Instructions, "EVENT SETTINGS."



Indicator meanings are as follows:

Indicator	Status	Meaning
Selection indicator	Unlit 	Amplifier's power is OFF, or it is placed in ON by another function.
	Lights green 	Amplifier's power is placed in ON by pressing this function key.
Status Indicator	Unlit 	Amplifier's power is OFF, or it is placed in ON through this function key operation.
	Lights green 	Amplifier's power is placed in ON by another function.

3. RM-300X REMOTE MICROPHONE AND RM-210F REMOTE MICROPHONE EXTENSION

3.1. Indicator State at the Time of Zone Selection







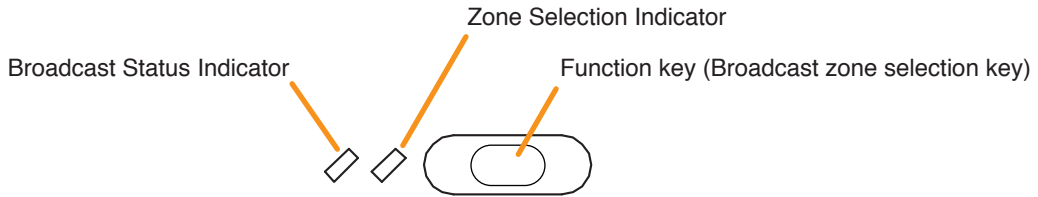

When a zone selection (pattern or individual) function has been assigned to a function key, the 2 indicators to the left of the key indicate its zone selection and broadcast status.

Note

For instructions on assigning functions to function keys, see the separate Setting Software Instructions, "EVENT SETTINGS."







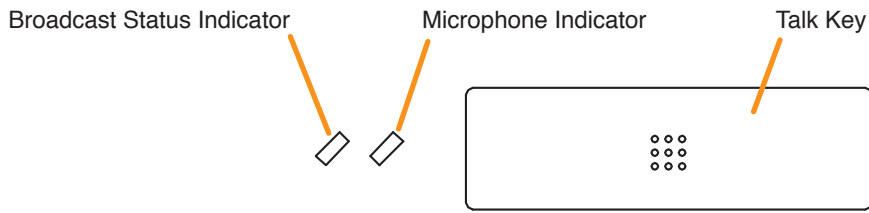

Indicator meanings are as follows:

Indicator	Status	Meaning
Zone Selection Indicator	Unlit 	No zone selected
	Lights green 	Zone selected
Broadcast Status Indicator	Unlit 	Zones assigned to this Broadcast Zone Selection key not in use or BGM broadcast in progress
	Flashes green 	A part of zones or the entire zone assigned to this Broadcast Zone Selection key is occupied by a broadcast from another device (secondary Remote Microphone or general EV message), or a part of zones is engaged by a broadcast from the primary Remote Microphone (RM-300X).
	Lights yellow 	All the zones selected by this Broadcast Zone Selection key on the primary Remote Microphone are engaged by a broadcast from the primary Remote Microphone.
	Flashes yellow 	All the zones assigned to this Broadcast Zone Selection key are engaged by a broadcast from the Secondary Emergency Remote Microphone.
	Lights red 	All the zones assigned to this Broadcast Zone Selection key are engaged by an evacuation message.
	Flashes red 	All the zones assigned to this Broadcast Zone Selection key are engaged by an alert message.
	Lights green 	All the zones assigned to this Broadcast Zone Selection key are engaged by a restoration message.

3.2. Talk Key Indicators



Indicator meanings are as follows:

Indicator	Status	Meaning
Microphone Indicator	Unlit 	Microphone not in use
	Lights green 	Microphone in use
	Flashes green 	Chime broadcast in progress from the primary Remote Microphone.
Broadcast Status Indicator	Unlit 	Zone not in use (microphone announcement possible)
	Flashes green 	A part of zones or the entire zone selected by the primary Remote Microphone is occupied by a broadcast from another device (secondary Remote Microphone, chime, etc.), or a broadcast from the primary Remote Microphone is in progress in a part of the zones selected by the primary Remote Microphone.
	Lights yellow 	All zones selected by the primary Remote Microphone are engaged by a broadcast from the primary Remote Microphone.

3.3. Indicator State at the Time of Base Pattern Change



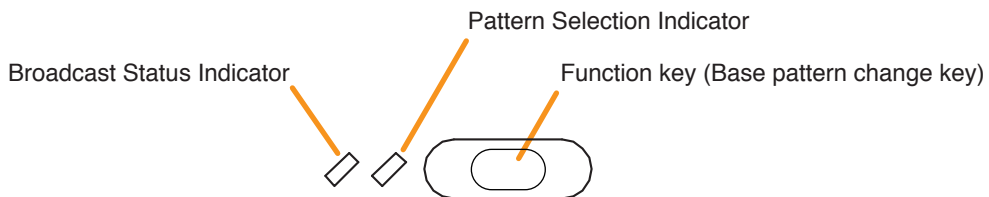

When a Base pattern change function has been assigned to a function key, the 2 indicators to the left of the key indicate its pattern selection and broadcast status.

Note

For instructions on assigning functions to function keys, see the separate Setting Software Instructions, "EVENT SETTINGS."



Indicator meanings are as follows:

Indicator	Status	Meaning
Pattern Selection Indicator	Unlit 	When the function key is not pressed
	Lights green 	When the function key is pressed (Lights briefly, then goes off)
Broadcast Status Indicator	Unlit 	When the Base pattern assigned to the function key is not being broadcast
	Lights yellow 	When the Base pattern assigned to the function key is being broadcast (including broadcasts activated by other devices)

3.4. Indicator State at the Time of General-Purpose Broadcast Pattern



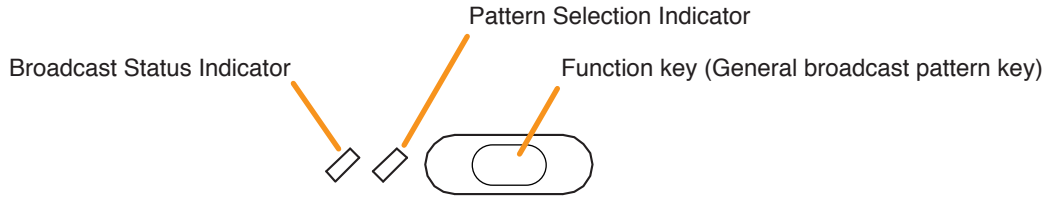

When a general-purpose broadcast pattern function has been assigned to a function key, the 2 indicators to the left of the key indicate its pattern selection and broadcast status.

Note

For instructions on assigning functions to function keys, see the separate Setting Software Instructions, "EVENT SETTINGS."



Indicator meanings are as follows:

Indicator	Status	Meaning
Pattern Selection Indicator	Unlit 	When the function key is not pressed
	Lights green 	When the function key is pressed
Broadcast Status Indicator	Unlit 	When the broadcast pattern assigned to the function key is not being broadcast
	Flashes yellow 	When the broadcast pattern assigned to the function key is being broadcast

3.5. Indicator State at the Time of General/BGM Broadcast



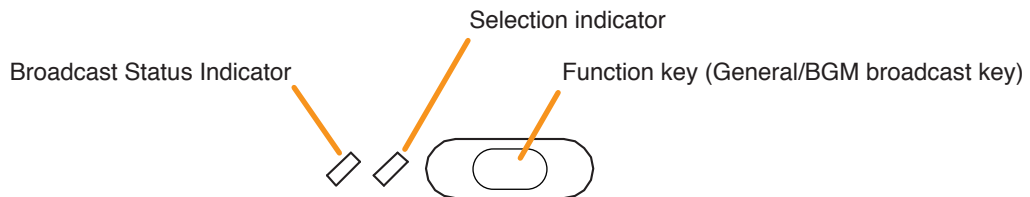

When a general/BGM broadcast function has been assigned to a function key, the 2 indicators to the left of the key indicate its selection and broadcast statuses.

Note

For instructions on assigning functions to function keys, see the separate Setting Software Instructions, "EVENT SETTINGS."



Indicator meanings are as follows:

Indicator	Status	Meaning
Selection Indicator	Unlit 	When the function key is not pressed
	Lights green 	When the unit is brought in general/BGM broadcast by pressing the function key
Broadcast Status Indicator	Unlit 	When a general/BGM broadcast assigned to the function key is not activated
	Lights green 	When the audio source for a general/BGM broadcast assigned to the function key is being broadcast to the zones other than those selected by this unit.
	Lights yellow 	When the audio source for a general/BGM broadcast assigned to the function key is being broadcast to at least one of the zones selected by this unit.

3.6. Indicator State at the Time of RM Broadcast Status Display



The Broadcast status indicator to the left of the Function key indicates the current broadcast status of other Remote Microphone.

Note

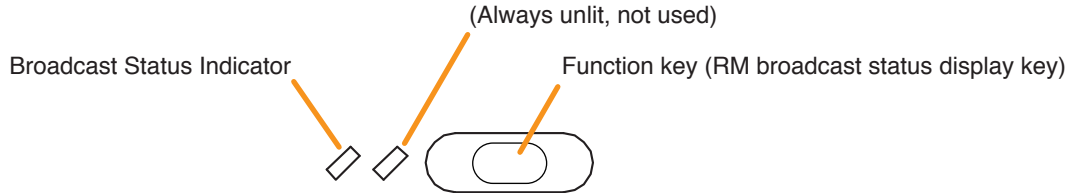
For instructions on assigning functions to function keys, see the separate Setting Software Instructions, "EVENT SETTINGS."



Indicator meanings are as follows:

Indicator	Status	Meaning
Broadcast Status Indicator	Unlit 	When the Remote Microphone assigned to the function key is not engaged in broadcasting
	Lights yellow 	When the Remote Microphone assigned to the function key is engaged in broadcasting

3.7. Indicator State at the Time of Lamp Test

When the lamp test function has been assigned to the Function key, the 2 indicators to the left of the key indicate the running status of the lamp test.



Pressing the Lamp Test key causes all indicators on the primary Remote Microphone to light, and the built-in buzzer to sound.

Note

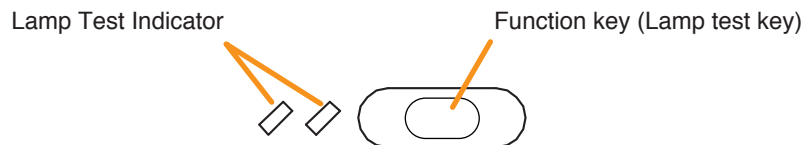
For instructions on assigning functions to function keys, see the separate Setting Software Instructions, "EVENT SETTINGS."



Indicator meanings are as follows:

Indicator	Status	Meaning
Lamp Test Indicator	Unlit 	When the function key is not pressed
	Lights yellow and green 	Lamp test has been executed by pressing the function key.

3.8. Indicator State at the Time of Failure Output Receipt

When the VX-3000 system is set to enable "Surveillance function," the failure output receipt function can be assigned to a function key.



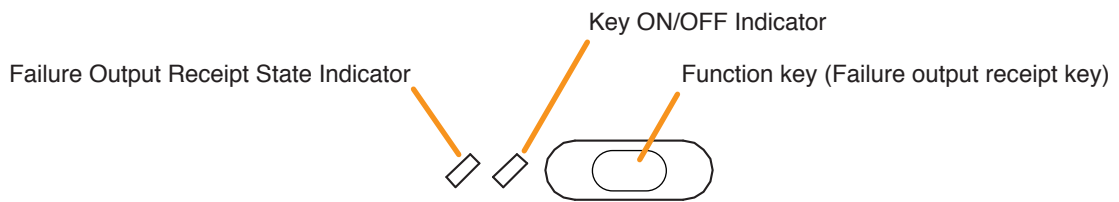

When the failure output receipt function has been assigned to the Function key, the 2 indicators to the left of the key indicate the occurrence and failure output receipt status of the failure output pattern.

Notes

- For instructions on setting the surveillance function, see the separate Setting Software Instructions, "BASIC SETTINGS."
- For instructions on assigning functions to function keys, see the separate Setting Software Instructions, "EVENT SETTINGS."



Indicator meanings are as follows:

Indicator	Status	Meaning
Key ON/OFF Indicator	Unlit 	When the function key is not pressed
	Lights green 	When the function key is pressed (as long as it is pressed)
Failure Output Receipt State Indicator	Flashes yellow 	When the failure output pattern assigned to the function key has occurred
	Lights yellow 	Failure output pattern has been acknowledged after pressing the function key.

3.9. Indicator State at the Time of Failure Output Reset

When the VX-3000 system is set to enable "Surveillance function," the failure output reset function can be assigned to a function key.



When the failure output reset function has been assigned to the Function key, the failure status indicator can be reset by pressing the key. The indicator to the left of the key lights only when the key is pressed.

Notes

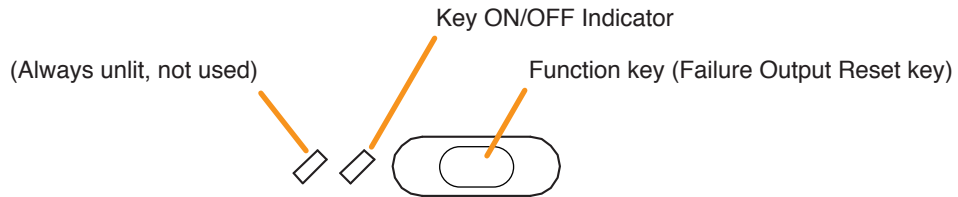
- For instructions on setting the surveillance function, see the separate Setting Software Instructions, "BASIC SETTINGS."
- For instructions on assigning functions to function keys, see the separate Setting Software Instructions, "EVENT SETTINGS."



Indicator meanings are as follows:

Indicator	Status	Meaning
Key ON/OFF Indicator	Unlit 	When the function key is not pressed
	Lights green 	When the function key is pressed (as long as it is pressed)

3.10. Indicator State at the Time of Emergency Broadcast Pattern Start

When the system is set to "Emergency" and the type of the RM-300X to "Emergency" or "Emergency/General," the emergency broadcast pattern start function can be assigned to the covered key or Function key. Pressing the function-assigned key causes the emergency to start.

When the covered key is assigned this function, the Emergency Indicator next to the key indicates the emergency condition of the VX-3000 system.

Meanwhile, when a function key is assigned this function, the 2 indicators next to the key indicate the emergency start and emergency states of the VX-3000 system.



Notes

- For the emergency function settings, see the separate Setting Software Instructions, "BASIC SETTINGS."
- For the type of the RM-300X settings, see the separate Setting Software Instructions, "Unit Configuration Settings."
- For instructions on assigning functions to the covered key and function keys, see the separate Setting Software Instructions, "EVENT SETTINGS."

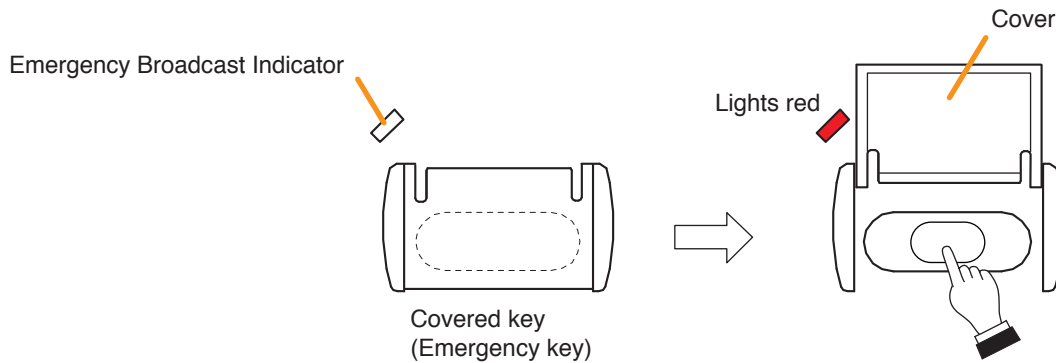
[When assigned to the covered key]









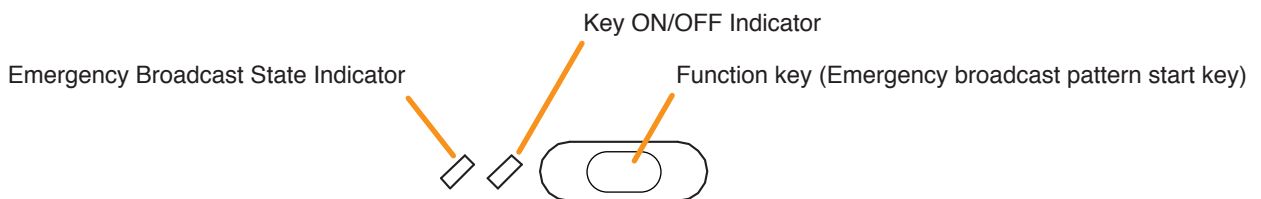

Indicator meanings are as follows:

Indicator	Status	Meaning
Emergency Broadcast Indicator	Unlit 	The VX-3000 system is not in an emergency condition.
	Lights red 	The Emergency Broadcast Pattern is started by pressing this Emergency key or the VX-3000 system is in an emergency condition.

[When assigned to the function key]



Indicator meanings are as follows:

Indicator	Status	Meaning
Key ON/OFF Indicator	Unlit  	When the function key is not pressed
	Lights green  	When the function key is pressed (as long as it is pressed)
Emergency Broadcast State Indicator	Unlit  	Emergency Broadcast Patterns assigned to the function key are not broadcast.
	Flashes red 	A part of Emergency Broadcast Patterns assigned to the function key is broadcast.
	Lights red  	All Emergency Broadcast Patterns assigned to the function key are broadcast.

3.11. Indicator State at the Time of Emergency Broadcast Pattern Stop



When the system is set to "Emergency" and the type of the RM-300X to "Emergency" or "Emergency/General," the emergency broadcast pattern stop function can be assigned to the Function key. Pressing the function-assigned key causes the emergency broadcast pattern to stop. The indicator to the left of the key lights only when the key is pressed.

Notes

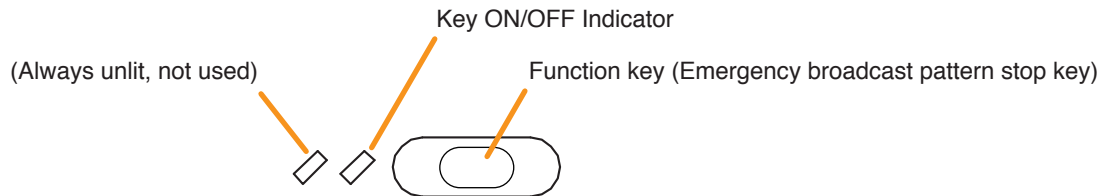
- For the emergency function settings, see the separate Setting Software Instructions, "BASIC SETTINGS."
- For the type of the RM-300X settings, see the separate Setting Software Instructions, "Unit Configuration Settings."
- For instructions on assigning functions to the function keys, see the separate Setting Software Instructions, "EVENT SETTINGS."



Indicator meanings are as follows:

Indicator	Status	Meaning
Key ON/OFF Indicator	Unlit 	When the function key is not pressed
	Lights green 	When the function key is pressed (as long as it is pressed)

3.12. Indicator State at the Time of Emergency Broadcast Pattern Start/Stop

When the system is set to "Emergency" and the type of the RM-300X to "Emergency" or "Emergency/General," the emergency broadcast pattern start/stop function can be assigned to the covered key or Function key. When the Emergency Broadcast Pattern set to the function-assigned key is OFF, pressing this key activates the emergency broadcast.

When the Emergency Broadcast Pattern set to the function-assigned key is ON, pressing this key stops the corresponding emergency broadcast pattern or returns the emergency mode to the normal state. The selection of which operation to perform depends on the setting.

When the covered key is assigned this function, the Emergency Indicator next to the key indicates the emergency condition of the VX-3000 system.

Meanwhile, when a function key is assigned this function, the 2 indicators next to the key indicate the emergency start and emergency states of the VX-3000 system.



Notes

- For the emergency function settings, see the separate Setting Software Instructions, "BASIC SETTINGS."
- For the type of the RM-300X settings, see the separate Setting Software Instructions, "Unit Configuration Settings."
- For instructions on assigning functions to the covered key and function keys, see the separate Setting Software Instructions, "EVENT SETTINGS."

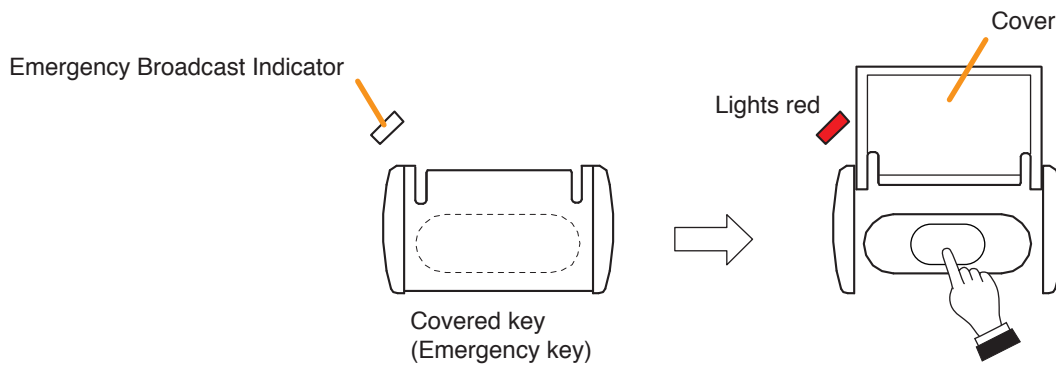
[When assigned to the covered key]





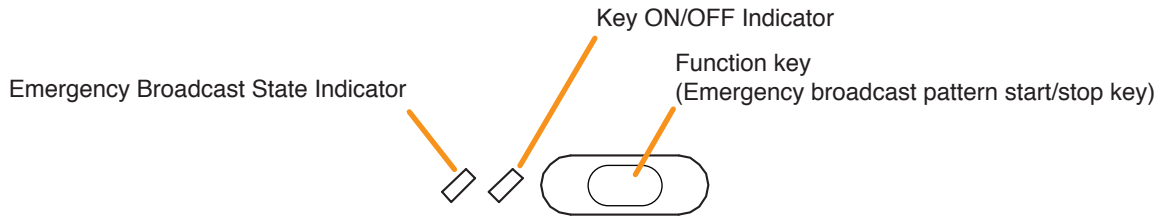

Indicator meanings are as follows:

Indicator	Status	Meaning
Emergency Broadcast Indicator	Unlit 	The VX-3000 system is not in an emergency condition.
	Lights red 	The Emergency Broadcast Pattern is started by pressing this Emergency key or the VX-3000 system is in an emergency condition.

[When assigned to the function key]



Indicator meanings are as follows:

Indicator	Status	Meaning
Key ON/OFF Indicator	Unlit 	When the function key is not pressed
	Lights green 	When the function key is pressed (as long as it is pressed)
Emergency Broadcast State Indicator	Unlit 	Emergency Broadcast Pattern assigned to the function key is not broadcast.
	Lights green 	Restoration Message broadcast assigned to the function key is being activated.
	Lights red 	Emergency Broadcast Pattern assigned to the function key is broadcast.

3.13. Indicator State at the Time of Emergency Sequence Stop



When the system is set to "Emergency" and the type of the RM-300X to "Emergency" or "Emergency/General," the emergency sequence stop function can be assigned to the Function key. Pressing the function-assigned key causes the emergency sequence to stop. The indicator to the left of the key lights only when the key is pressed.

Notes

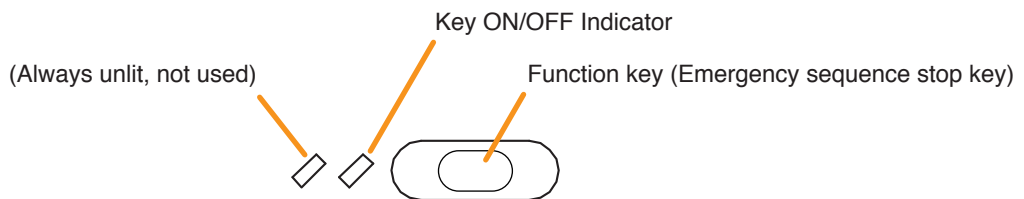
- For the emergency function settings, see the separate Setting Software Instructions, "BASIC SETTINGS."
- For the type of the RM-300X settings, see the separate Setting Software Instructions, "Unit Configuration Settings."
- For instructions on assigning functions to the function keys, see the separate Setting Software Instructions, "EVENT SETTINGS."



Indicator meanings are as follows:

Indicator	Status	Meaning
Key ON/OFF Indicator	Unlit 	When the function key is not pressed
	Lights green 	When the function key is pressed (as long as it is pressed)

3.14. Indicator State at the Time of Emergency Sequence Phase Shift



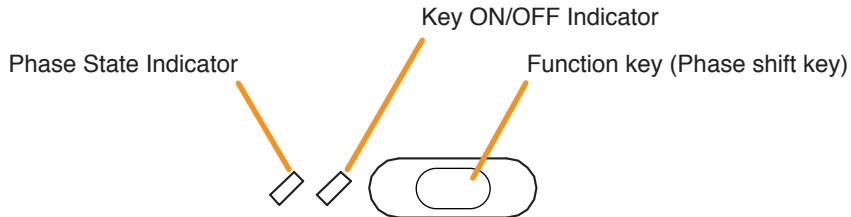

When the system is set to "Emergency" and the type of the RM-300X to "Emergency" or "Emergency/General," the emergency sequence phase shift function can be assigned to a function key. Assigning this function to the Function key causes the 2 indicators next to the Function key to indicate the emergency sequence phase state.

Notes

- For the emergency function settings, see the separate Setting Software Instructions, "BASIC SETTINGS."
- For the type of the RM-300X settings, see the separate Setting Software Instructions, "Unit Configuration Settings."
- For instructions on assigning functions to function keys, see the separate Setting Software Instructions, "EVENT SETTINGS."



Indicator meanings are as follows:

Indicator	Status	Meaning
Key ON/OFF Indicator	Unlit 	When the function key is not pressed
	Lights green 	When the function key is pressed (as long as it is pressed)
Phase State Indicator	Lights green 	Emergency sequence assigned to the function key is in Phase 1.
	Flashes green 	Emergency sequence assigned to the function key is in Phase 2.
	Unlit 	Emergency sequence assigned to the function key is in Phase 3.

3.15. Indicator State at the Time of Emergency Reset

When the system is set to "Emergency" and the type of the RM-300X to "Emergency" or "Emergency/General," the emergency reset function can be assigned to a function key.

Pressing the function-assigned key causes all the activated emergency broadcast patterns to stop, allowing the emergency broadcast status to be reset after the restoration EV message broadcast completion.



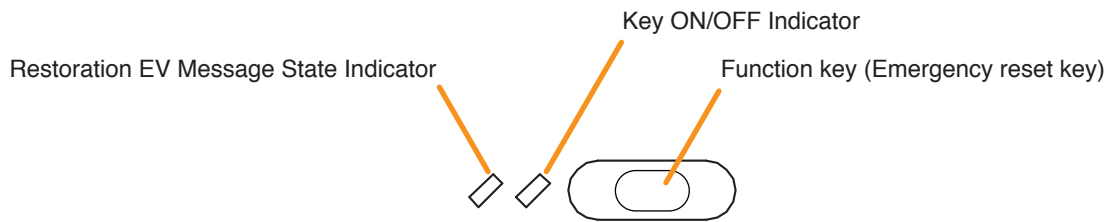

Assigning this function to the Function key causes the 2 indicators next to the Function key to indicate the emergency reset state.

Notes

- For the emergency function settings, see the separate Setting Software Instructions, "BASIC SETTINGS."
- For the type of the RM-300X settings, see the separate Setting Software Instructions, "Unit Configuration Settings."
- For instructions on assigning functions to function keys, see the separate Setting Software Instructions, "EVENT SETTINGS."



Indicator meanings are as follows:

Indicator	Status	Meaning
Key ON/OFF Indicator	Unlit 	When the function key is not pressed
	Lights green 	When the function key is pressed (as long as it is pressed)
Restoration EV Message State Indicator	Unlit 	Restoration Message broadcast assigned to the function key is being stopped.
	Lights green 	Restoration Message broadcast assigned to the function key is being activated.

3.16. Indicator State at the Time of Emergency Broadcast Silence

When the system is set to "Emergency" and the type of the RM-300X to "Emergency" or "Emergency/General," the emergency broadcast silence function can be assigned to the Function key.

The emergency broadcast silence function is a function to mute the output of the EV sound sources of which audio source type is set to "Evacuate" or "Alert." Pressing the key to which this function is assigned once turns ON the function. Pressing it again turns OFF the function.



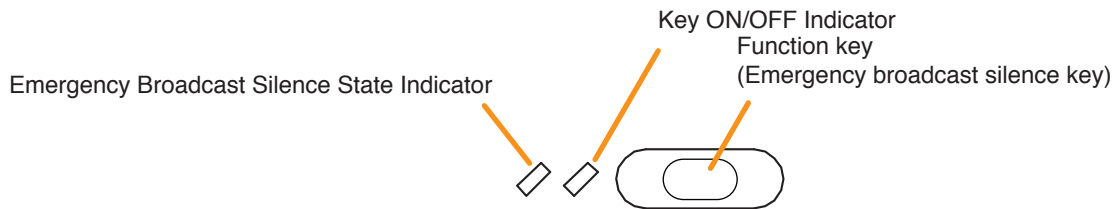

When this function has been assigned to the Function key, whether the emergency broadcast silence function is ON or OFF can be checked depending on the lighting statuses of the 2 indicators next to the Function key.

Notes

- For the emergency function settings, see the separate Setting Software Instructions, "BASIC SETTINGS."
- For the type of the RM-300X settings, see the separate Setting Software Instructions, "Unit Configuration Settings."
- For instructions on assigning functions to the function key, see the separate Setting Software Instructions, "EVENT SETTINGS."
- The emergency broadcast silence function is valid only when the system is in the emergency mode.
- The emergency broadcast silence function changes to OFF if you reset the emergency mode while the emergency broadcast silence function remains ON.



Indicator meanings are as follows:

Indicator	Status	Meaning
Key ON/OFF Indicator	Unlit 	When the function key is not pressed
	Lights green 	When the function key is pressed (as long as it is pressed)
Emergency Broadcast Silence State Indicator	Unlit 	When the emergency broadcast silence function is not valid
	Flashes green 	When the emergency broadcast silence function is valid

3.17. Indicator State at the Time of Emergency EV Broadcast

When the system is set to "Emergency" and the type of the RM-300X to "Emergency" or "Emergency/General," the emergency EV broadcast function can be assigned to the covered key or Function key.

Assigning the Emergency EV broadcast function to the key allows the EV sound source of which audio type is set to "Evacuate" or "Alert" only to be manually activated only while the system is in emergency mode.

When the covered key is assigned this function, the Emergency Broadcast Indicator next to the key indicates the broadcast status.

Meanwhile, when a function key is assigned this function, the 2 indicators next to the key indicate its selection and control statuses.



Notes

- For the emergency function settings, see the separate Setting Software Instructions, "BASIC SETTINGS."
- For the type of the RM-300X settings, see the separate Setting Software Instructions, "Unit Configuration Settings."
- For instructions on assigning functions to the covered key and function keys, see the separate Setting Software Instructions, "EVENT SETTINGS."

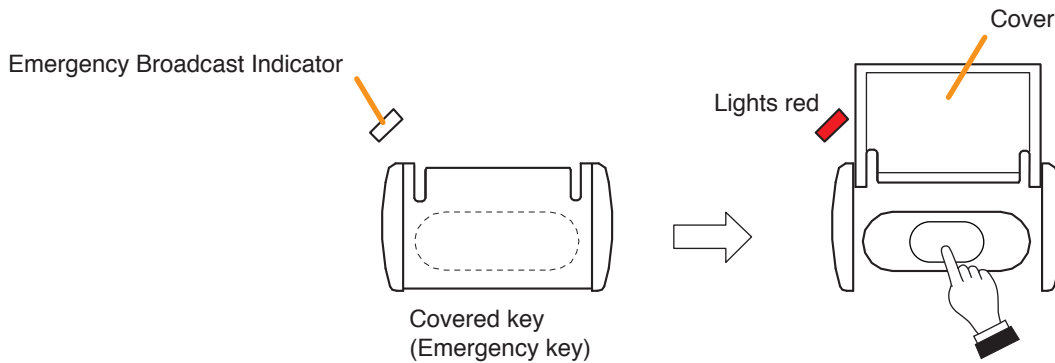
[When assigned to the covered key]





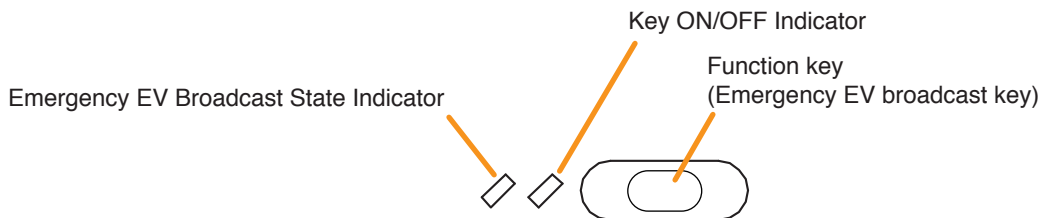

Indicator meanings are as follows:

Indicator	Status	Meaning
Emergency Broadcast Indicator	Unlit 	When the Emergency EV message assigned to the Emergency key is not broadcast to any zones
	Lights red 	When the Emergency EV message assigned to the Emergency key is broadcast to at least a part of the zones

[When assigned to the function key]



Indicator meanings are as follows:

Indicator	Status	Meaning
Key ON/OFF Indicator	Unlit 	When the function key is not pressed
	Lights green 	When the function key is pressed
Emergency EV Broadcast State Indicator	Unlit 	When the Emergency EV message assigned to the Emergency key is not broadcast to any zones
	Lights red 	When the Emergency EV message assigned to the Emergency key is broadcast to at least a part of the zones

3.18. Indicator State at the Time of Emergency Acknowledge

When the system is set to "Emergency" and the type of the RM-300X to "Emergency" or "Emergency/General," the emergency EV broadcast function can be assigned to the covered key or Function key.

If the Emergency acknowledge function has been assigned to the key, the buzzer built in the remote microphone sounds when the emergency broadcast pattern assigned to this key turns ON. You can stop the buzzer sound by pressing the Emergency acknowledge function assigned key.

When the Emergency acknowledge function has been assigned to the covered key, the Emergency Broadcast Indicator next to the key indicates the broadcast status.

When the Emergency acknowledge function has been assigned to the function key, the 2 indicators next to the key indicate the emergency broadcast activation and emergency acknowledge status.



Notes

- For the emergency function settings, see the separate Setting Software Instructions, "BASIC SETTINGS."
- For the type of the RM-300X settings, see the separate Setting Software Instructions, "Unit Configuration Settings."
- For instructions on assigning functions to the Emergency key and function keys, see the separate Setting Software Instructions, "EVENT SETTINGS."

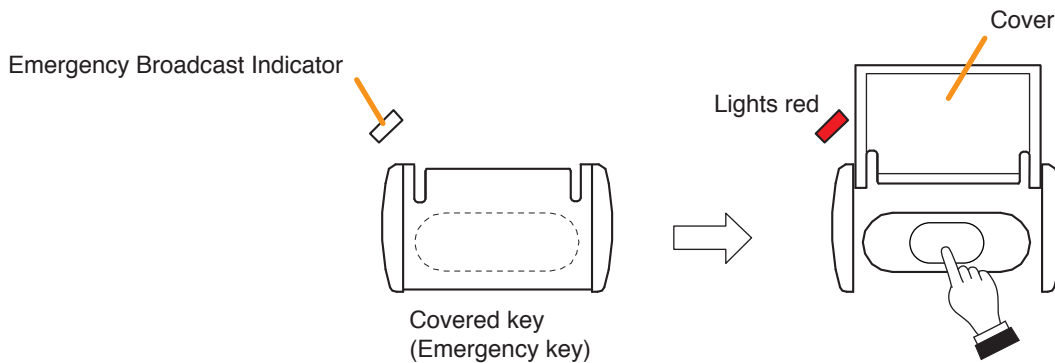
[When assigned to the covered key]



Indicator meanings are as follows:



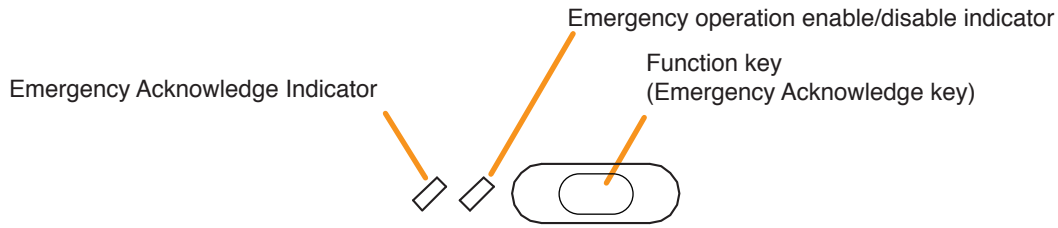

Indicator	Status	Meaning
Emergency Broadcast Indicator	Unlit 	Emergency operation* from this remote microphone is disabled.
	Flashes red 	When the buzzer is sounding: Emergency acknowledge has not been received by this remote microphone and emergency operation* from this remote microphone is disabled. When the buzzer is not sounding: Emergency operation* from this remote microphone is enabled.
	Lights red 	When Emergency acknowledge has been received by this remote microphone and emergency operation* from this remote microphone is enabled.

* All operations related to the emergency broadcasts such as Emergency broadcast pattern start/stop, Emergency sequence phase shift, and Emergency reset.

[When assigned to the function key]



Indicator meanings are as follows:

Indicator	Status	Meaning
Emergency operation* ¹ enable/disable indicator	Unlit 	When set to EMG enable operation ON* ² : Emergency operation from this remote microphone is disabled. When set to EMG operation OFF* ³ (Constantly unlit)
	Lights green 	When set to EMG enable operation ON* ² : Emergency operation* ¹ from this remote microphone is enabled.
Emergency Acknowledge Indicator	Unlit 	When the system is not in emergency mode
	Flashes red 	When the system is in emergency mode and emergency acknowledge has not been received by this remote microphone.
	Lights red 	When the system is in emergency mode and emergency acknowledge has been received by this remote microphone.

*¹ All operations related to the emergency broadcasts such as Emergency broadcast pattern start/stop, Emergency sequence phase shift, and Emergency reset.
 *² It is so set by the VX-3000 Setting Software that Emergency operation cannot be performed until the emergency acknowledge key is pressed once the emergency broadcast pattern has been activated.
 *³ It is so set by the VX-3000 Setting Software that Emergency operation can be performed without pressing the emergency acknowledge key once the emergency broadcast pattern has been activated.

3.19. Indicator State at the Time of Disablement of EMG Control from CIN

When the system is set to "Emergency" and the type of the RM-300X to "Emergency" or "Emergency/General," the "disablement of EMG control from CIN" function can be assigned to the function key.

When this function is assigned to the function key, you can stop the emergency activation from the control input when the system is in general mode.

This function is intended not to activate the emergency broadcast by the fire alarm system during maintenance. When this function is assigned to 2 or more remote microphones, it can be made invalid only by performing cancellation operation at all these remote microphones.

When this function is assigned to the function key, the 2 indicators next to the key indicate the key selection status, enable/disable status of the function, and acknowledge status.

This function is enabled only when the system is in general mode. Even if you press the key to which this function is assigned while the system is in emergency mode, a beep tone will sound, making the operation invalid.



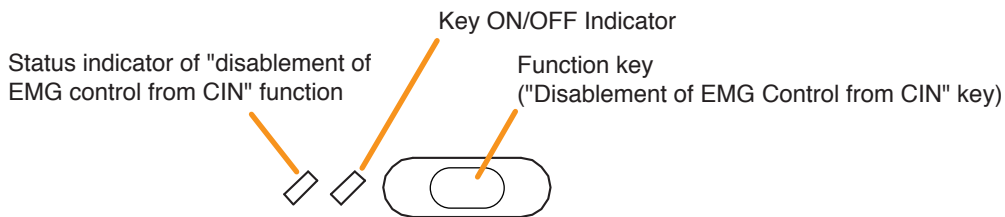

You can set a warning buzzer notifying that this function is being left ON. When this warning buzzer is set to ON, a beep tone will sound once every 10 seconds at the remote microphone where this function has been activated, indicating that the emergency activation from the control input is placed in invalid status. When this function is turned OFF at the remote microphone, the beep tone only at the operated remote microphone will stop.

Notes

- For the emergency function settings, see the separate Setting Software Instructions, "BASIC SETTINGS."
- For the type of the RM-300X settings, see the separate Setting Software Instructions, "Unit Configuration Settings."
- For instructions on assigning functions to the function key, see the separate Setting Software Instructions, "EVENT SETTINGS."



Indicator meanings are as follows:

Indicator	Status	Meaning
Key ON/OFF Indicator	Unlit 	When the function key is not pressed
	Lights green 	When the function key is pressed
Status indicator of "disablement of EMG control from CIN" function	Unlit 	When the disablement function of emergency activation from the control input is set to OFF
	Flashes red 	When the disablement function of emergency activation from the control input is turned ON by other remote microphone
	Lights red 	When the disablement function of emergency activation from the control input is turned ON by this remote microphone or when the status that this function is turned ON by other remote microphone is acknowledged

3.20. Indicator State at the Time of Audio Monitor

When an audio monitor function has been assigned to a function key, the 2 indicators to the left of the key indicate its selection and audio monitor statuses.



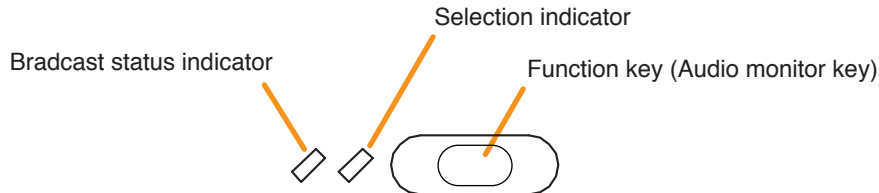

Note

Only one remote microphone can be used for audio monitoring even when 2 or more remote microphones are connected to a single VX-3000F.

Only the remote microphone of which Audio monitor key is pressed most recently is effective for audio monitoring, causing other remote microphone engaged in monitoring to be interrupted.



Indicator meanings are as follows:

Indicator	Status	Meaning
Selection indicator	Unlit 	When the function key is not pressed
	Lights green 	When the function key is pressed
Broadcast status indicator	Unlit 	When no broadcast is made to the zone assigned to this function key
	Lights green 	When the function key is pressed while audio signals are being broadcast to the zone assigned to this function key

3.21. Indicator State at the Time of Intended Control Input

When an intended control input function has been assigned to a function key, the 2 indicators to the left of the key indicate its selection and control statuses.

Note



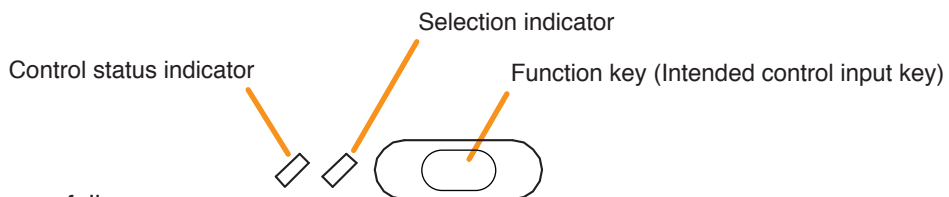

Operation may become invalid even if you press the function key when the Control status indicator is lighting. This is such a case when the control input is placed in Active state by other device.

Wait until the Control status indicator goes off, then press the function key again.

Function key operation is always active as long as the Control status indicator is unlit.



Indicator meanings are as follows:

Indicator	Status	Meaning
Selection indicator	Unlit 	When the function key is not pressed
	Lights green 	When the function key is pressed
Control status indicator	Unlit 	When the control input assigned to this function key is in Inactive* state
	Lights yellow 	When the control input assigned to this function key is in Active* state

* When the control input polarity is set to "NO" in the Event setting, the function key becomes Active while the control input is closed, and becomes Inactive when it is open.

Conversely, when the polarity is set to "NC," the function key becomes Active while the control input is open, and becomes Inactive when it is closed.

3.22. Indicator State at the Time of Intended Control Output (Pulse)



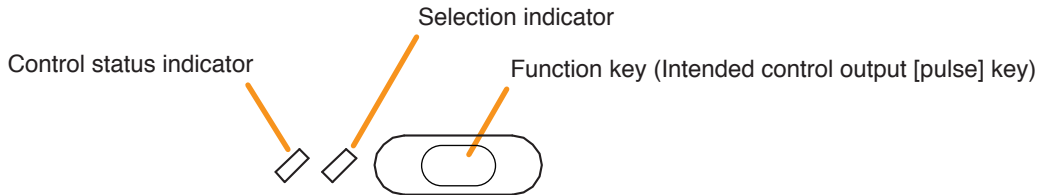

When the intended control output (pulse) function is assigned to the function key, pressing this key turns ON the preset control output. It is turned OFF when this key is pressed again. When an intended control output (pulse) function has been assigned to a function key, the 2 indicators to the left of the key indicate its selection and control statuses.

Note

Operation may become invalid even if you press the function key when the Control status indicator is lighting. This is such a case when the Control output pattern is being activated by other Event. Wait until the Control status indicator goes off, then press the function key again. Function key operation is always active as long as the Control status indicator is unlit.



Indicator meanings are as follows:

Indicator	Status	Meaning
Selection indicator	Unlit 	When the function key is not pressed
	Lights green 	When the function key is pressed
Control status indicator	Unlit 	When the Control output pattern assigned to this function key is not activated
	Lights yellow 	When the Control output pattern assigned to this function key is being activated

3.23. Indicator State at the Time of Intended Control Output (Level)



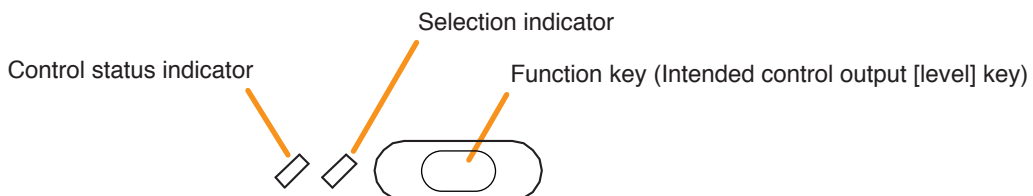

When the intended control output (level) function is assigned to the function key, the preset control output is turned ON while this key is held down. It is turned OFF when this key is released. When an intended control output (level) function has been assigned to a function key, the 2 indicators to the left of the key indicate its selection and control statuses.

Note

Operation may become invalid even if you press the function key when the Control status indicator is lighting. This is such a case when the Control output pattern is being activated by other Event. Wait until the Control status indicator goes off, then press the function key again. Function key operation is always active as long as the Control status indicator is unlit.



Indicator meanings are as follows:

Indicator	Status	Meaning
Selection indicator	Unlit 	When the function key is not pressed
	Lights green 	When the function key is pressed (as long as it is pressed)
Control status indicator	Unlit 	When the Control output pattern assigned to this function key is not activated
	Lights yellow 	When the Control output pattern assigned to this function key is being activated

3.24. Indicator State at the Time of Zone Volume Adjustment (Pulse)



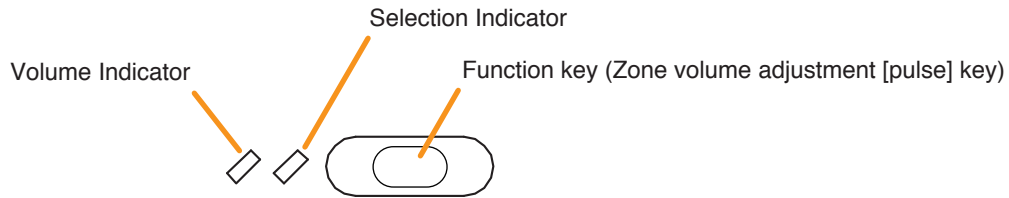

When the Zone volume adjustment (Pulse) function is assigned to the function key, pressing this key increases or decreases the volume level of the preset zone by the set amount. Sound adjustment status can be checked by the indicators to the left of the function key.

Note

For instructions on assigning functions to function keys, see the separate Setting Software Instructions, "EVENT SETTINGS."



Indicator meanings are as follows:

Indicator	Status	Meaning
Selection indicator	Unlit 	When the function key is not pressed
	Lights green 	When the function key is pressed (as long as it is pressed)
Volume Indicator	Unlit 	In the case the set value ^{*1} of the volume adjustment is positive (volume increase): When the current volume adjustment value of the zone assigned to this key is the initial value ^{*2} or less In the case the set value ^{*1} of the volume adjustment is negative (volume decrease): When the current volume adjustment value of the zone assigned to this key is the initial value ^{*2} or grater
	Lights green 	In the case the set value ^{*1} of the volume adjustment is positive (volume increase): When the current volume adjustment value of the zone assigned to this key is greater than the initial value ^{*2} In the case the set value ^{*1} of the volume adjustment is negative (volume decrease): When the current volume adjustment value of the zone assigned to this key is less than the initial value ^{*2}

*1 Value set in "Event setting" of the VX-3000 Setting Software.

*2 Volume set in "Sound settings (output)" of the VX-3000 Setting Software.

3.25. Indicator State at the Time of Input Volume Adjustment (Pulse)



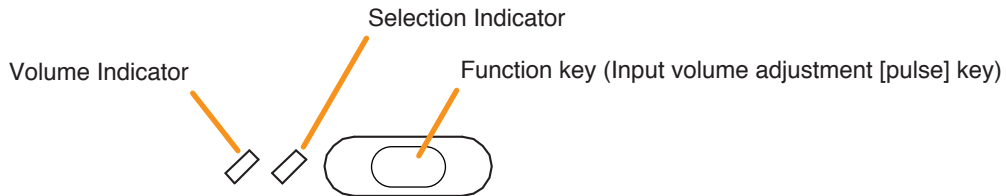

When the Input volume adjustment (Pulse) function is assigned to the function key, pressing this key increases or decreases the volume level of the preset Input channel by the set amount. Sound adjustment status can be checked by the indicators to the left of the function key.

Note

For instructions on assigning functions to function keys, see the separate Setting Software Instructions, "EVENT SETTINGS."



Indicator meanings are as follows:

Indicator	Status	Meaning
Selection indicator	Unlit 	When the function key is not pressed
	Lights green 	When the function key is pressed (as long as it is pressed)
Volume Indicator	Unlit 	In the case the set value* ¹ of the volume adjustment is positive (volume increase): When the current volume adjustment value of the input channel assigned to this key is the initial value* ² or less In the case the set value* ¹ of the volume adjustment is negative (volume decrease): When the current volume adjustment value of the input channel assigned to this key is the initial value* ² or greater
	Lights green 	In the case the set value* ¹ of the volume adjustment is positive (volume increase): When the current volume adjustment value of the input channel assigned to this key is greater than the initial value* ² In the case the set value* ¹ of the volume adjustment is negative (volume decrease): When the current volume adjustment value of the input channel assigned to this key is less than the initial value* ²

*¹ Value set in "Event setting" of the VX-3000 Setting Software.

*² Volume set in "Sound settings (input)" of the VX-3000 Setting Software.

3.26. Indicator State at the Time of Emergency Warning Broadcast

The emergency warning broadcast function can be assigned to the covered key or function key. Pressing this key activates the emergency warning broadcast.

When the covered key is assigned this function, a indicator to the left of the key indicate its broadcast statuses. Meanwhile, when an emergency warning broadcast function has been assigned to a function key, the 2 indicators to the left of the key indicate its selection and broadcast statuses.



Note

For instructions on assigning functions to the covered key and function keys, see the separate Setting Software Instructions, "EVENT SETTINGS."

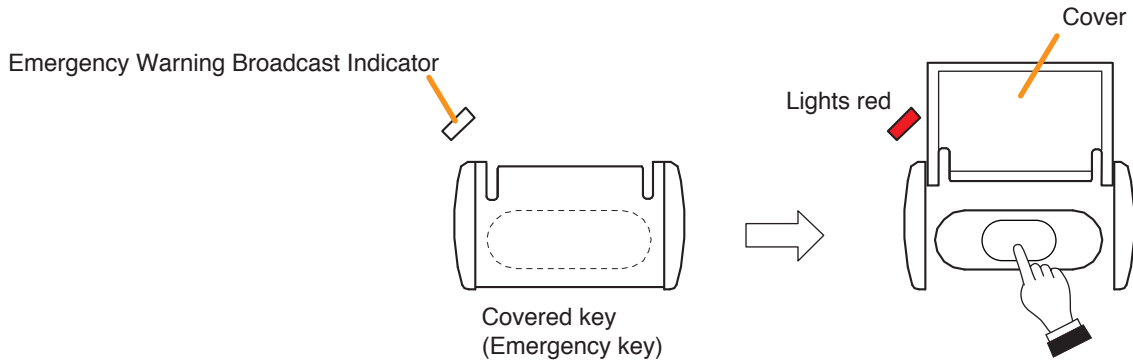
[When assigned to the covered key]









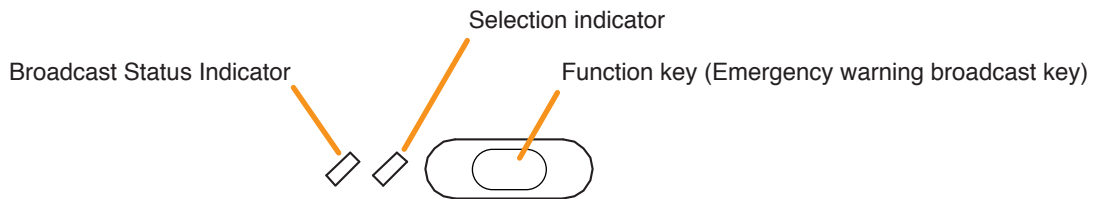



Indicator meanings are as follows:

Indicator	Status	Meaning
Emergency Warning Broadcast Indicator	Unlit 	When the audio source for an emergency warning broadcast assigned to the Emergency key is not broadcast to any zones
	Lights red 	When the audio source for an emergency warning broadcast assigned to the Emergency key is broadcast to at least a part of the zones assigned to this key

[When assigned to the function key]



Indicator meanings are as follows:

Indicator	Status	Meaning
Selection Indicator	Unlit  	When the function key is not pressed
	Lights green  	When the function key is pressed
Broadcast Status Indicator	Unlit  	When the audio source for an emergency warning broadcast assigned to the function key is not broadcast to any zones
	Lights green  	When the audio source for an emergency warning broadcast assigned to the function key is broadcast to the zones other than those assigned to this key
	Lights yellow  	When the audio source for an emergency warning broadcast assigned to the function key is broadcast to at least a part of the zones assigned to this key

3.27. Indicator State at the Time of Sleep Mode Power On

When the VX-3000 system is set to enable "Sleep mode function," the power on function can be assigned to a function key.



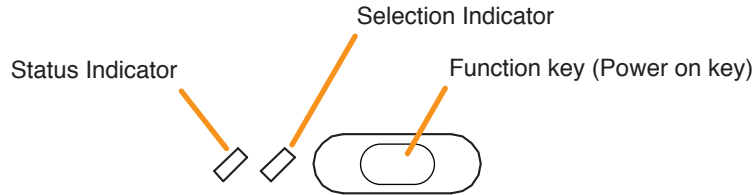

Pressing the key to which this function is assigned while in sleep mode turns the amplifier's power ON, and pressing it when the amplifier's power is ON switches to the sleep mode.

Notes

- For instructions on setting sleep mode function, see the separate Setting Software Instructions, "BASIC SETTINGS."
- For instructions on assigning functions to the Emergency key and function keys, see the separate Setting Software Instructions, "EVENT SETTINGS."



Indicator meanings are as follows:

Indicator	Status	Meaning
Selection Indicator	Unlit 	Amplifier's power is OFF, or it is placed in ON by another function.
	Lights green 	Amplifier's power is placed in ON by pressing this function key.
Status Indicator	Unlit 	Amplifier's power is OFF, or it is placed in ON through this function key operation.
	Lights green 	Amplifier's power is placed in ON by another function.

4. RM-500'S LCD SCREEN DISPLAY

In normal use state, the following contents are displayed on the LCD screen.

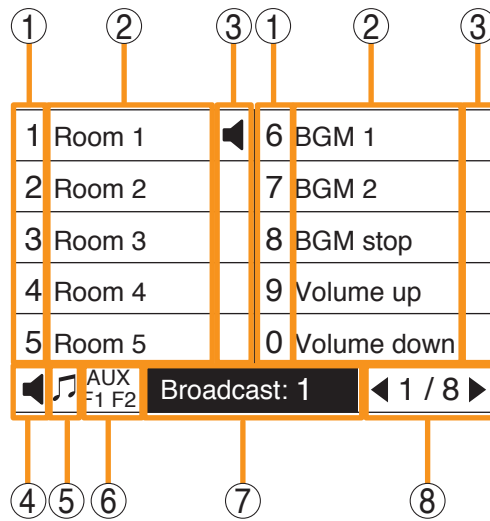

1. Numbers

Displays the number corresponding to the numeric key.

2. Function display area

Displays the function name.

3. Individual icon display area

Displays the state of the function corresponding to the number by an icon.

4. Overall icon display area

Displays the icon that represents the state of the function with the highest display priority in the statuses of all functions assigned to this unit.

5. Chime display area

Displays the chime icon shown below when the chime is sounding by this unit's operation.



Microphone level can also be displayed as shown below if so set. You can check if the microphone level is appropriate even during broadcasts.

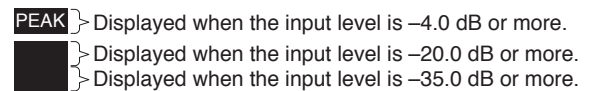

6. AUX/Function display area

Displays the function of the AUX key and the state of the F1/F2 key.

7. Broadcast status display area

Displays the broadcast status of the whole function assigned to this unit.

8. Page display

Displays the current page/total page.

[Icon display list]

Icon	Name	Display priority level	Meaning of icon
	Emergency broadcast in progress	High	Emergency broadcast is in progress.
	Broadcast from another unit in progress		Broadcast from another unit is in progress.
	Broadcast in progress		Microphone announcements or AUX broadcast is in progress from this unit, or zones are being selected (including the broadcast after zone selection is in progress). Simultaneously check the display in the broadcast status display area (7).
	Control input in operation	Low	Indicates that the control input of this unit is in make state. This icon is dedicated for the overall icon display area (4).
	Others in operation	-	Displayed only in the Individual icon display area (3). The function assigned to the function display on the LCD screen is operating.

[Broadcast status display list]

Broadcast status	Meaning of display
Broadcast: n*	Broadcast is being made from this unit to the broadcast destination set in the function display on the LCD screen. In this case, the display area is highlighted (example: Broadcast: 1).
Broadcast: All	Broadcast is being made from this unit to the broadcast destination set in the ALL key. In this case, the display area is highlighted (example: Broadcast: All).
Mic. Paging: n*	Microphone paging is being made from this unit to the broadcast destination set in the function display on the LCD screen. In this case, the display area is highlighted (example: Mic. Paging: 1).
Mic. Paging: All	Microphone paging is being made from this unit to the broadcast destination set in the ALL key. In this case, the display area is highlighted (example: Mic. Paging: All).
Sel. Zone: n*	The broadcast destination set in the function display on the LCD screen is selected.
Sel. Zone: All	The broadcast destination assigned to the ALL key is selected.
On Hold: n*	Broadcast cannot be made from this unit because other broadcasts with higher priority are being made to all the zones set in the function display on the LCD screen.
On Hold: All	Broadcast cannot be made from this unit because other broadcasts with higher priority are being made to all the zones assigned to the ALL key.

* "n" indicates the number of the functions displayed on the LCD screen being activated for broadcasts.

[AUX/F1/F2 display list]

AUX display	Meaning of display
AUX	AUX broadcast of the RM-500's own unit is set to the AUX key. The AUX display area is highlighted (AUX) when the unit becomes in broadcast status.
None	No function is set to the AUX key. Nothing works even when the AUX key is pressed.

The state of the F1 key and F2 key are also displayed below the AUX indication.

F1/F2 display	Meaning of display
F1	Displays the state of the F1 key. The indication is highlighted (F1) when the F1 key is ON.
F2	Displays the state of the F2 key. The indication is highlighted (F2) when the F2 key is ON.

4.1. Indicator State at the Time of Zone Selection

When a zone selection (pattern or individual) function has been assigned to a function display, the displays of the function display area and individual icon display area indicate its zone selection and broadcast status.

Note

For instructions on assigning functions to function displays, see the separate Setting Software Instructions, "EVENT SETTINGS."

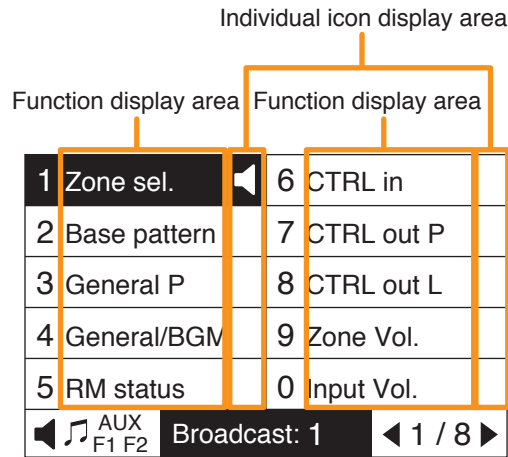

Display areas meanings are as follows:

Display	Display name	Example	Meaning
Normal display/ Highlighted display	Normal display	1 Zone sel.	No zone selected
	Highlighted display	1 Zone sel.	Zone selected
Icon display	None	-	Zones assigned to this function display not in use or BGM broadcast in progress
	Broadcast from another unit in progress		In any of the following cases: <ul style="list-style-type: none"> A part of zones or the entire zone assigned to this function display is occupied by a broadcast from another device (secondary Remote Microphone or general EV message), or a part of zones is engaged by a broadcast from the primary Remote Microphone (RM-500). All the zones assigned to this function display are engaged by a broadcast from the Secondary Emergency Remote Microphone. All the zones assigned to this function display are engaged by a restoration message.
	Broadcast in progress		All the zones selected by this function display on the primary Remote Microphone are engaged by a broadcast from the primary Remote Microphone.
	Emergency broadcast in progress		In any of the following cases: <ul style="list-style-type: none"> All the zones assigned to this function display are engaged by an evacuation message. All the zones assigned to this function display are engaged by an alert message.

4.2. Talk Indicator and Microphone Indicator

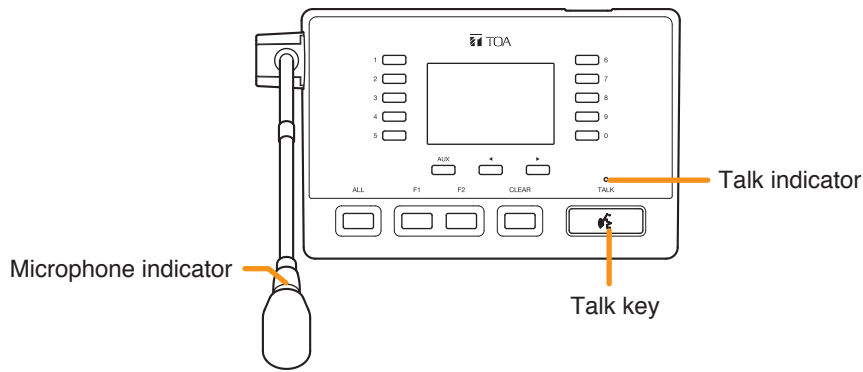

Indicator meanings are as follows:

Indicator	Status	Meaning
Microphone Indicator	Unlit	When the Talk key is not operated When microphone announcements are being made from the microphone connected to the AUX input terminal When the Microphone indicator is set to "OFF"
	Lit	When microphone announcements are being made from this unit's microphone
Talk Indicator	Unlit	When the Talk key is not operated
	Lit	When microphone announcements are being made by the Talk key operation

4.3. Indicator State at the Time of Base Pattern Change

When a Base pattern change function has been assigned to a function display, the displays of the function display area and individual icon display area indicate its pattern selection and broadcast status.

Note

For instructions on assigning functions to function displays, see the separate Setting Software Instructions, "EVENT SETTINGS."

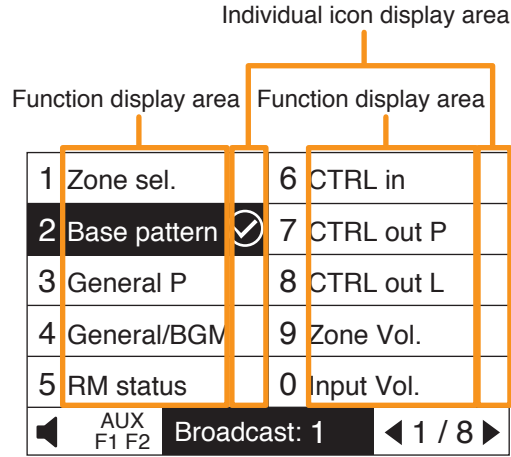

Display areas meanings are as follows:

Display	Display name	Example	Meaning
Normal display/ Highlighted display	Normal display	2 Base pattern	When this function display is not selected
	Highlighted display	2 Base pattern	When this function display is selected (Returns to normal display shortly after highlighted.)
Icon display	None	-	When the Base pattern assigned to this function display is not being broadcast
	Others in operation		When the Base pattern assigned to this function display is being broadcast (including broadcasts activated by other devices)

4.4. Indicator State at the Time of General-Purpose Broadcast Pattern

When a general-purpose broadcast pattern function has been assigned to a function display, the displays of the function display area and individual icon display area indicate its pattern selection and broadcast status.

Note

For instructions on assigning functions to function displays, see the separate Setting Software Instructions, "EVENT SETTINGS."

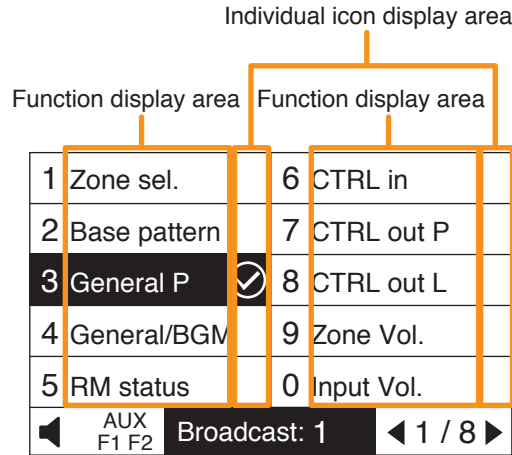

Display areas meanings are as follows:

Display	Display name	Example	Meaning
Normal display/ Highlighted display	Normal display	2 Base pattern	When this function display is not selected
	Highlighted display	2 Base pattern	When this function display is selected
Icon display	None	-	When the broadcast pattern assigned to this function display is not being broadcast
	Others in operation	⊙	When the broadcast pattern assigned to this function display is being broadcast

4.5. Indicator State at the Time of General/BGM Broadcast

When a general/BGM broadcast function has been assigned to a function display, the displays of the function display area and individual icon display area indicate its selection and broadcast statuses.

Note

For instructions on assigning functions to function displays, see the separate Setting Software Instructions, "EVENT SETTINGS."

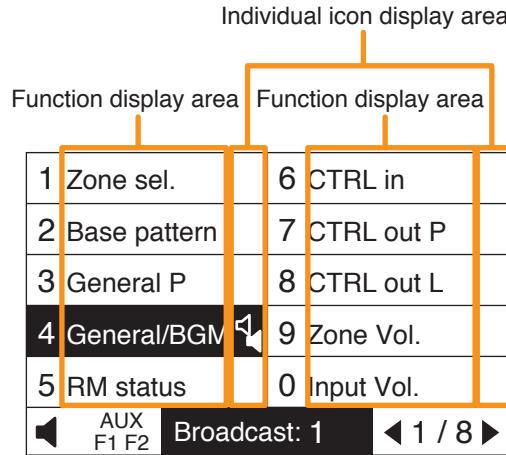

Display areas meanings are as follows:

Display	Display name	Example	Meaning
Normal display/ Highlighted display	Normal display	4 General/BGM	When this function display is not selected
	Highlighted display	4 General/BGM	When this function display is selected
Icon display	None	-	When a general/BGM broadcast assigned to this function display is not activated
	Others in operation		When the audio source for a general/BGM broadcast assigned to this function display is being broadcast to the zones other than those selected by this unit.
	Broadcast from another unit in progress		When the audio source for a general/BGM broadcast assigned to this function display is being broadcast to at least one of the zones selected by this unit.

4.6. Indicator State at the Time of RM Broadcast Status Display

When an RM broadcast status display function has been assigned to a function display the display of the icon display area indicates the current broadcast status of other Remote Microphone.

Note

For instructions on assigning functions to function displays, see the separate Setting Software Instructions, "EVENT SETTINGS."

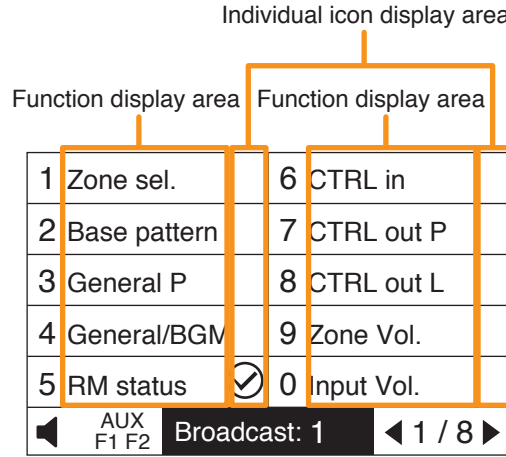

Display areas meanings are as follows:

Display	Display name	Example	Meaning
Normal display/ Highlighted display	Normal display	5 RM status	Always normal display (Not highlighted)
	Not highlighted	–	
Icon display	None	–	When the Remote Microphone assigned to this function display is not engaged in broadcasting
	Others in operation		When the Remote Microphone assigned to this function display is engaged in broadcasting

4.7. Indicator State at the Time of Intended Control Input

When an intended control input function has been assigned to a function display, the displays of the function display area and individual icon display area indicate its selection and control statuses.

Notes

- Even if you select the function display while it is highlighted, the operation may become invalid. This is such a case when the control input is placed in Active state by other device. Select the function display again after the indication returns to normal display. When in normal display, the selection operation of the function display is always enabled.
- For instructions on assigning functions to function displays, see the separate Setting Software Instructions, "EVENT SETTINGS."

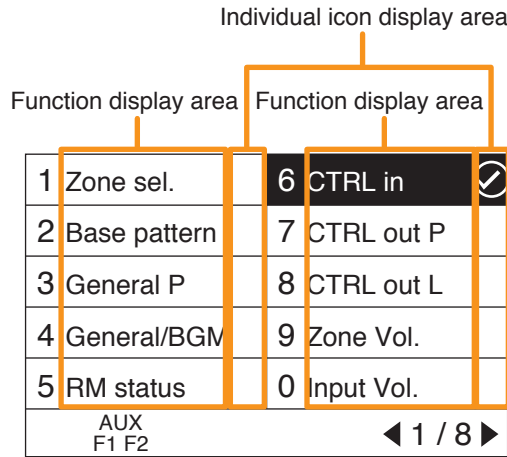

Display areas meanings are as follows:

Display	Display name	Example	Meaning
Normal display/ Highlighted display	Normal display	6 CTRL in	When this function display is not selected
	Highlighted display	6 CTRL in	When this function display is selected
Icon display	None	-	When the control input assigned to this function display is in Inactive* state
	Others in operation	☑	When the control input assigned to this function display is in Active* state

* When the control input polarity is set to "NO" in the Event setting, the function display becomes Active while the control input is closed, and becomes Inactive when it is open. Conversely, when the polarity is set to "NC," the function key becomes Active while the control input is open, and becomes Inactive when it is closed.

4.8. Indicator State at the Time of Intended Control Output (Pulse)

When the intended control output (pulse) function is assigned to the function display, selecting this display turns ON the preset control output. It is turned OFF when this display is selected again.
 When an intended control output (pulse) function has been assigned to a function display, the displays of the function display area and individual icon display area indicate its selection and control statuses.

Notes

- Even if you select the function display while it is highlighted, the operation may become invalid. This is such a case when the Control output pattern is being activated by other Event. Select the function display again after the indication returns to normal display. When in normal display, the selection operation of the function display is always enabled.
- For instructions on assigning functions to function displays, see the separate Setting Software Instructions, "EVENT SETTINGS."

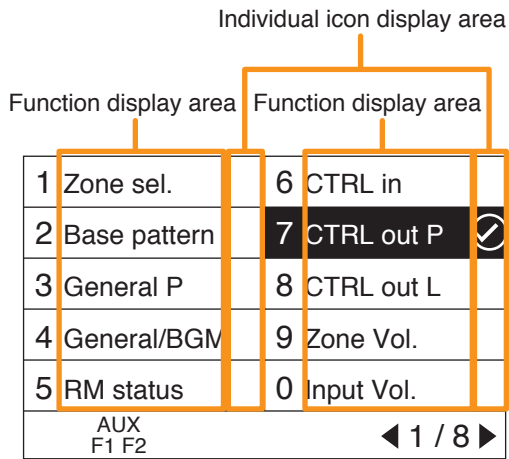

Display areas meanings are as follows:

Display	Display name	Example	Meaning
Normal display/ Highlighted display	Normal display	7 CTRL out P	When this function display is not selected
	Highlighted display	7 CTRL out P	When this function display is selected
Icon display	None	-	When the Control output pattern assigned to this function display is not activated
	Others in operation	✔	When the Control output pattern assigned to this function display is being activated

4.9. Indicator State at the Time of Intended Control Output (Level)

When an intended control output (LEVEL) function has been assigned to a function display on the LCD screen, the preset control output is turned on only while the numeric key corresponding to this function display is being pressed. It turns off when you release the key.

When an intended control output (level) function has been assigned to a function display, the displays of the function display area and individual icon display area indicate its selection and control statuses.

Notes

- Even if you select the function display while it is highlighted, the operation may become invalid. This is such a case when the Control output pattern is being activated by other Event. Select the function display again after the indication returns to normal display. When in normal display, the selection operation of the function display is always enabled.
- For instructions on assigning functions to function displays, see the separate Setting Software Instructions, "EVENT SETTINGS."

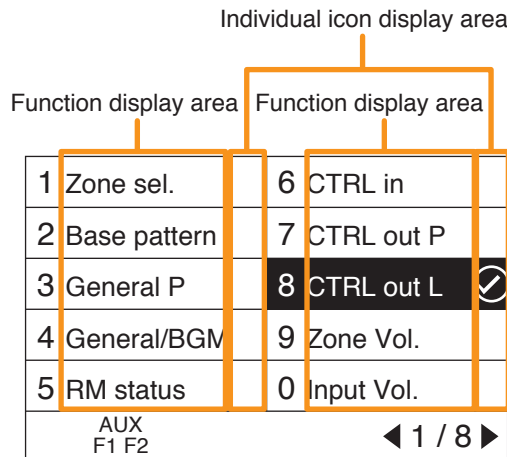

Display areas meanings are as follows:

Display	Display name	Example	Meaning
Normal display/ Highlighted display	Normal display	8 CTRL out L	When this function display is not selected
	Highlighted display	8 CTRL out L	When this function display is selected (only while the numeric key corresponding to this function display is being pressed)
Icon display	None	-	When the Control output pattern assigned to this function display is not activated
	Others in operation	✔	When the Control output pattern assigned to this function display is being activated

4.10. Indicator State at the Time of Zone Volume Adjustment (Pulse)

When the Zone volume adjustment (Pulse) function is assigned to the function display, selecting this display increases or decreases the volume level of the preset zone by the set amount. You can check the volume adjustment state that is displayed in the lower part of the LCD screen.

Note

For instructions on assigning functions to function displays, see the separate Setting Software Instructions, "EVENT SETTINGS."

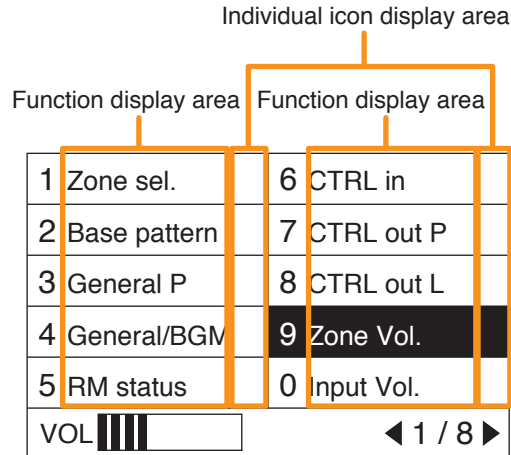

Display areas meanings are as follows:

Display	Display name	Example	Meaning
Normal display/ Highlighted display	Normal display	9 Zone Vol.	When this function display is not selected
	Highlighted display	9 Zone vol.	When this function display is selected (only while the numeric key corresponding to this function display is being pressed)
Icon display	None	-	Not displayed

When you perform the volume adjustment operation, the volume level is displayed on the LCD screen for about 3 seconds as shown in the figure below.

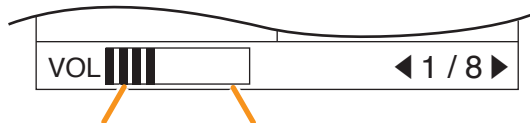

Current level is shown by the number of vertical bars. Reference level is shown by the frame.

4.11. Indicator State at the Time of Input Volume Adjustment (Pulse)

When the Input volume adjustment (Pulse) function is assigned to the function display, selecting this display increases or decreases the volume level of the preset Input channel by the set amount. You can check the volume adjustment state that is displayed in the lower part of the LCD screen.

Note

For instructions on assigning functions to function displays, see the separate Setting Software Instructions, "EVENT SETTINGS."

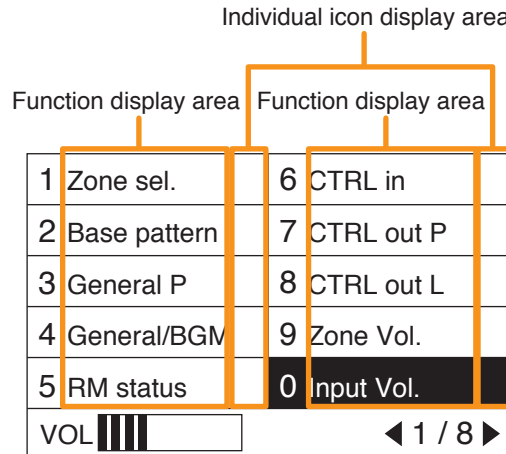

Display areas meanings are as follows:

Display	Display name	Example	Meaning
Normal display/ Highlighted display	Normal display	0 Input Vol.	When this function display is not selected
	Highlighted display	0 Input vol.	When this function display is selected (only while the numeric key corresponding to this function display is being pressed)
Icon display	None	–	Not displayed

When you perform the volume adjustment operation, the volume level is displayed on the LCD screen for about 3 seconds as shown in the figure below.

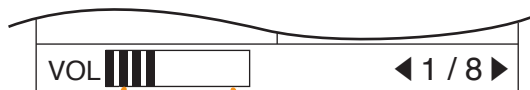

Current level is shown by the number of vertical bars.

Reference level is shown by the frame.

4.12. Indicator State at the Time of Emergency Warning Broadcast

The emergency warning broadcast function can be assigned to the function display. Selecting this display activates the emergency warning broadcast.

When an emergency warning broadcast function has been assigned to a function display, the displays of the function display area and individual icon display area indicate its selection and broadcast statuses.

Note

For instructions on assigning functions to the function displays, see the separate Setting Software Instructions, "EVENT SETTINGS."

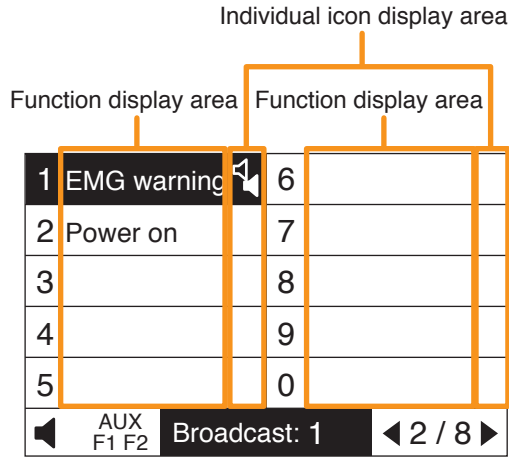

Display areas meanings are as follows:

Display	Display name	Example	Meaning
Normal display/ Highlighted display	Normal display	1 EMG warning	When this function display is not selected
	Highlighted display	4 EMG warning	When this function display is selected (only while the numeric key corresponding to this function display is being pressed)
Icon display	None	-	When the audio source for an emergency warning broadcast assigned to this function display is not broadcast to any zones
	Others in operation	⊙	When the audio source for an emergency warning broadcast assigned to this function display is broadcast to the zones other than those assigned to this display
	Broadcast from another unit in progress	🔊	When the audio source for an emergency warning broadcast assigned to this function display is broadcast to at least a part of the zones assigned to this display

4.13. Indicator State at the Time of Sleep Mode Power On

When the VX-3000 system is set to enable "Sleep mode function," the power on function can be assigned to a function display.

Selecting the function display to which this function is assigned while in sleep mode turns the amplifier's power ON, and pressing it when the amplifier's power is ON switches to the sleep mode.

Notes

- For instructions on setting sleep mode function, see the separate Setting Software Instructions, "BASIC SETTINGS."
- For instructions on assigning functions to the function displays, see the separate Setting Software Instructions, "EVENT SETTINGS."

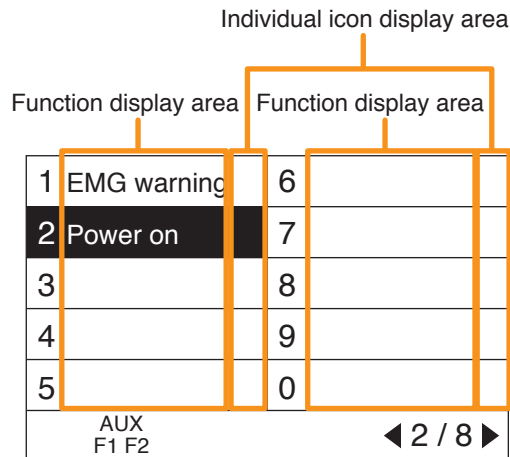

Display areas meanings are as follows:

Display	Display name	Example	Meaning
Normal display/ Highlighted display	Normal display	2 Power on	Amplifier's power is OFF, or it is placed in ON by another function.
	Highlighted display	2 Power on	Amplifier's power is placed in ON by selecting this function display.
Icon display	None	-	Amplifier's power is OFF, or it is placed in ON through this function display operation.
	Others in operation		Amplifier's power is placed in ON by another function.

Chapter 3

OPERATION

1. BGM AND GENERAL BROADCAST

1.1. Broadcasting from the Remote Microphone or the Control Panel

The function keys of the RM-200SF/320F/300X/210F/500 Remote microphone can be used to make microphone announcements, to change or end BGM broadcasts, and to activate or end general-purpose and general/BGM broadcasts.

The function keys of the VX-3000CT Control panel can be used to change or end BGM broadcasts, and to activate or end general-purpose and general/BGM broadcasts.

For instructions on assigning functions to function keys, see the separate Setting Software Instructions, "EVENT SETTINGS."

The example here shows the RM-300X, but the basic operation and displays are the same for the RM-200SF, RM-320F, and RM-210F. The VX-3000CT's function key does not permit microphone announcements, but it permits BGM broadcasts and general broadcasts in the same way as described above.

Concerning the RM-500, see [p. 3-10](#) for basic operations and [p. 2-61](#) for displays.

1.2. Assignment Example

[Setting example to function keys of the remote microphone]

Key	Item Name	Function
Function key R1	Zones 1, 2 and 3	Zone selection (pattern)
Function key R2	Zone 1	Zone selection (individual)
Function key R3	Zone 2	Zone selection (individual)
Function key R4	Zone 3	Zone selection (individual)
Function key R5	Zone clear	Clear pre selected zones
Function key R6	General broadcast pattern 1	Activation and end of general broadcast pattern 1 broadcast
Function key R7	General/BGM broadcast	Activation and end of audio source for general/BGM broadcast
Function key R8	Zone 1 volume up	Zone volume adjustment (pulse)
Function key R9	Zone 1 volume down	Zone volume adjustment (pulse)
Function key 11	Input 1 volume up	Input volume adjustment (pulse)
Function key 12	Input 1 volume down	Input volume adjustment (pulse)
Function key L1	BGM pattern 1	Activation of base pattern 1 broadcast
Function key L2	BGM pattern 2	Activation of base pattern 2 broadcast
Function key L3	BGM end	Interrupt base broadcast pattern
Talk key		Lock type, Start Chime: 1, End Chime: None

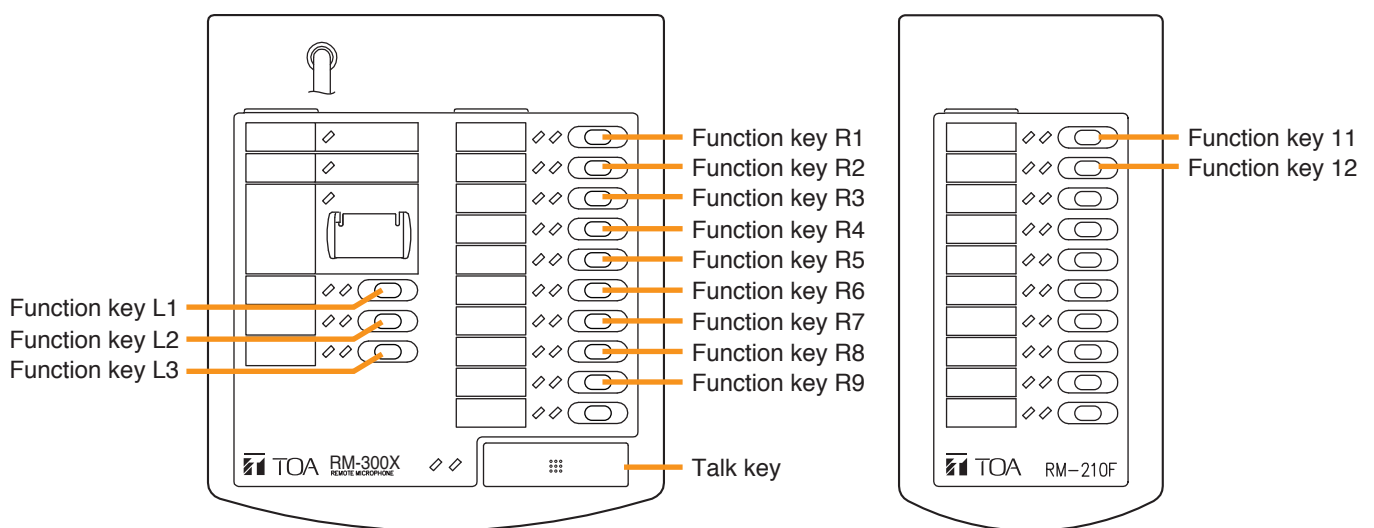

1.3. Operation Examples

1.3.1. Example of microphone announcements made to the selected (pattern-designated) zones

Step 1. Press Function key R1 (Zones 1, 2 and 3).
All of the designated zones are selected, and the zone selection indicator next to Function key R1 lights green.

Note
To cancel the selection, press Function key R1 again, or press Function key R5 (Zone clear).
The zone selection indicator will go off.

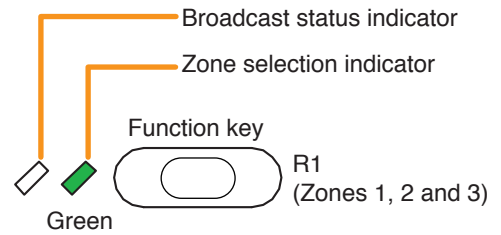

Step 2. Press the Talk key.
A chime will be broadcast. This chime will be audible through the monitor speaker built in the RM-300X.



The Microphone indicator flashes green while the chime is being activated.

Note
Pressing the Talk key again while the chime is being activated causes the chime to stop, ending the broadcast in progress.

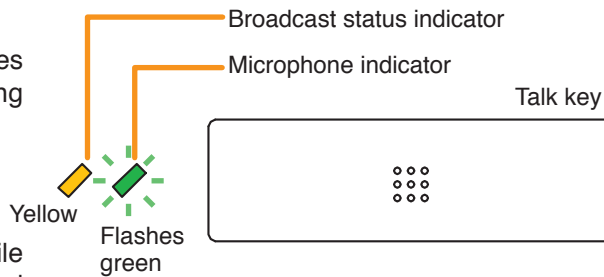

Step 3. When the microphone indicator next to the Talk key lights green, make the microphone announcement.
The zones assigned to Function keys R2 – R4 are included within the zone selection pattern assigned to Function key R1. Therefore, the broadcast status indicators next to Function keys R2 – R4 will light yellow in the same way.

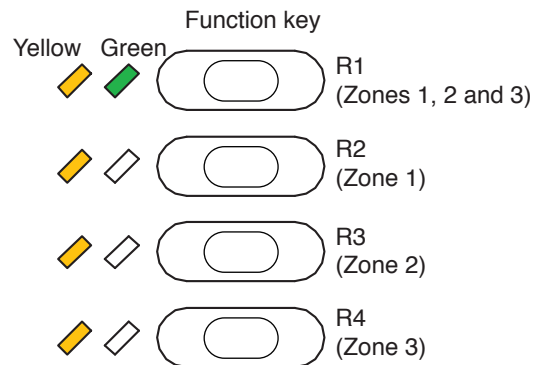

Step 4. Press the Talk key.
The broadcast ends.

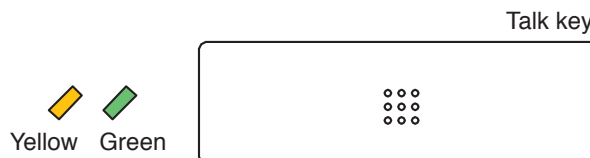

Step 5. Press Function key R5 (Zone clear).
The zone selection is cancelled.

Note
If it is desired that the zone selection be left unchanged, there is no need to clear the selected zones.

1.3.2. Example of microphone announcements made to the selected (individual) zones

Step 1. Press Function key R2 (Zone 1) and Function key R3 (Zone 2).
Zones 1 and 2 are selected, and their zone selection indicators light green.

Note

To cancel a selected zone, press the Function key for that zone again. The zone selection indicator for that key will go off.

To cancel all selected zones, press Function key R5 (Zone clear). Both zone selection indicators will go off.

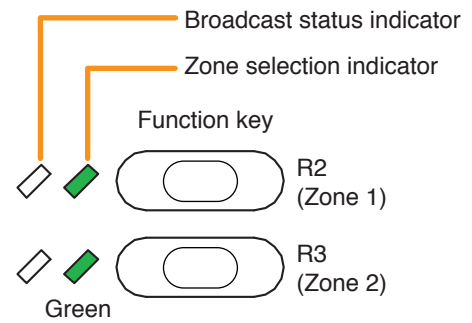

Step 2. Press the Talk key.

A chime will be broadcast. This chime will be audible through the monitor speaker built in the RM-300X.

The Microphone indicator flashes green while the chime is being activated.

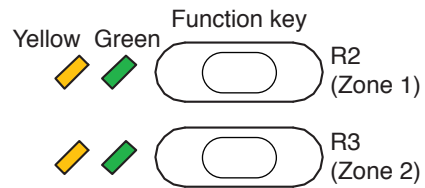

Note

Pressing the Talk key again while the chime is being activated causes the chime to stop, ending the broadcast in progress.

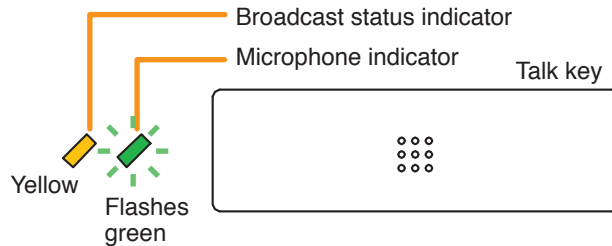

Step 3. When the microphone indicator next to the Talk key lights green, make the microphone announcement. Because a portion of the pattern assigned to Function key R1 is included in the selected zones, the broadcast status indicator next to this key will flash green.

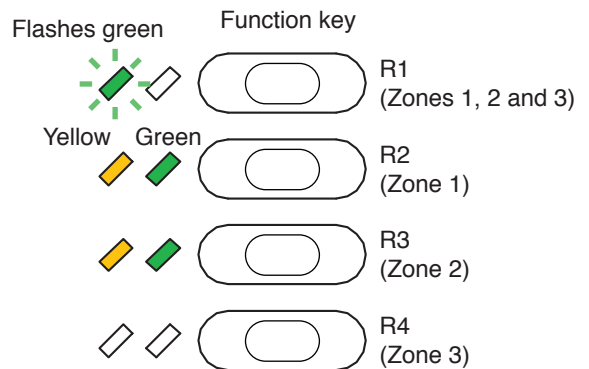

Step 4. Press the Talk key.
The broadcast ends.

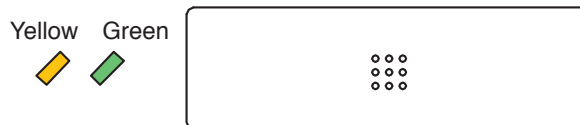

Step 5. Press Function key R5 (Zone clear).
The zone selection is cancelled.

Note

If it is desired that the zone selection be left unchanged, there is no need to clear the selected zones.

1.3.3. Example of microphone announcements made to the preset zones

You can make broadcasts from the remote microphone to the preset zones only by pressing the Talk key if you assign the broadcast zone pattern or individual zone to the Talk key in advance.

Note

For instructions on assigning zone pattern or individual zone to talk key, see the separate Setting Software Instructions, "EVENT SETTINGS."

Step 1. Press the Talk key.

Zones preset to the Talk key will be selected, and a chime will be broadcast. This chime will be audible through the monitor speaker built in the RM-300X.

The Microphone indicator flashes green while the chime is being activated.

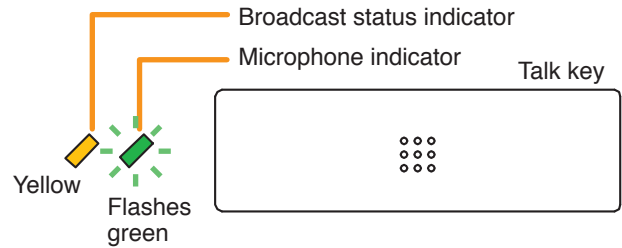

Note

Pressing the Talk key again while the chime is being activated causes the chime to stop, ending the broadcast in progress.

Step 2. When the microphone indicator next to the Talk key lights green, make the microphone announcement.



Step 3. Press the Talk key.

The broadcast ends.

1.3.4. Example of BGM broadcasting

Following is the operation example in the case where BGM broadcast is made by the BGM pattern 1 in the morning and changed to the BGM pattern 2 in the afternoon, and then ended.

Step 1. Press the Function key L1 (BGM pattern 1).
 BGM pattern 1 is selected and activated.
 After the pattern selection indicator next to Function key L1 lights green then goes off, the broadcast status indicator lights yellow.

Note
 To cancel the selection, press Function key L3 (BGM end). The broadcast status indicator will go off.

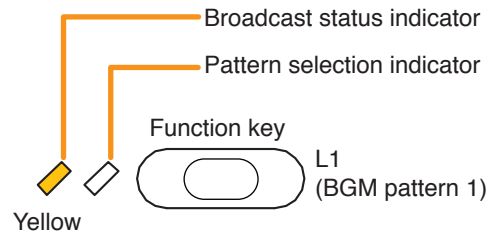

Step 2. Press the Function key L2 (BGM pattern 2).
 BGM pattern 2 is selected, ending BGM pattern 1, and BGM pattern 2 is activated.
 After the pattern selection indicator next to Function key L2 lights green then goes off, the broadcast status indicator lights yellow.
 The broadcast status indicator next to Function key L1 goes off.

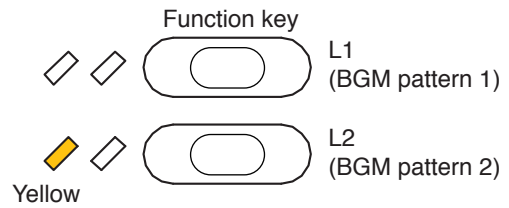

Step 3. Press the Function key L3 (BGM end).
 BGM ends. All indicators go off.

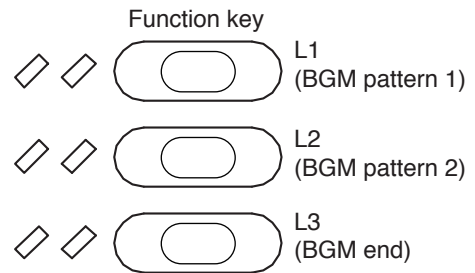

1.3.5. Example of general broadcasting

Step 1. Press the Function key R6 (General broadcast pattern 1).
 General broadcast pattern 1 is selected and activated.
 After the selection indicator next to Function key R6 lights green, the broadcast status indicator flashes yellow.

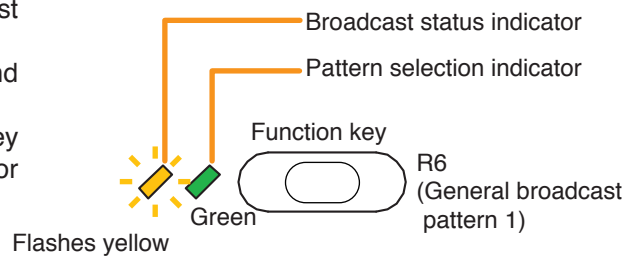

Step 2. Press the Function key R6 (General broadcast pattern 1) again.
 General broadcast pattern 1 being activated stops.
 The pattern selection indicator and the broadcast status indicator next to Function key R6 go off.

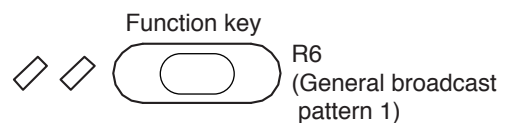

1.3.6. Example of general/BGM broadcasting

Here, an operation example based on the zone patterns is explained.

Step 1. Press the function key R1 (Zones 1, 2, and 3).
All the set zones are selected, and the zone selection indicator of the function key R1 lights green.

Note
To cancel the selection, press the function key R1 again or the function key R5 (Zone clear).
The zone selection indicator goes off.

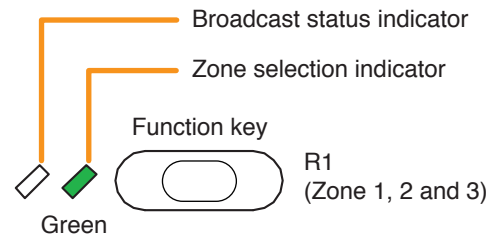

Step 2. Press the function key R7 (General/BGM broadcast).

The audio source for the general broadcast or BGM use is broadcast to the selected zones.
The Zone selection indicator of the function key R7 lights green, and the Broadcast status indicator lights yellow.
Also Broadcast status indicators of the function keys R1, R2, R3, and R4 flash green.

Tip
Performing this operation during the microphone announcements made by this unit terminates the microphone announcements if the audio source assigned to the general/BGM broadcasts takes precedence over the microphone announcements.

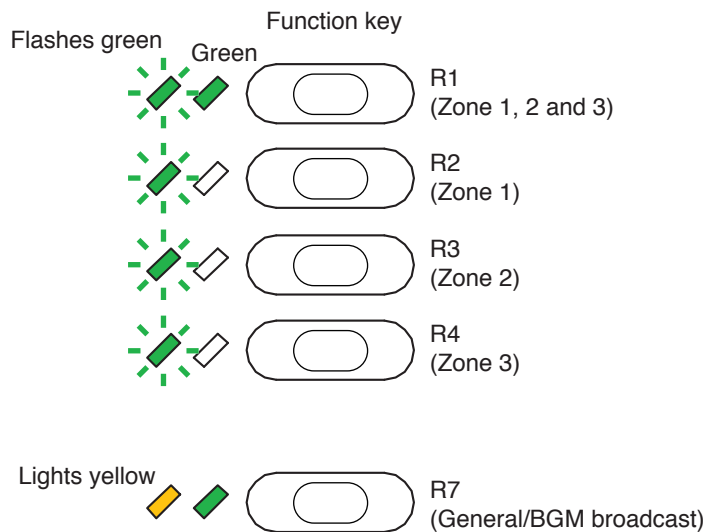

1.3.7. Example of zone volume adjustment

[When increasing the volume level of the preset zone]

Step: Press the function key R8 (Zone 1 volume up) several times until the volume becomes the desired level.
Each time the key is pressed, the volume level of the set zone or that of the zone pattern increases by the set amount.
The volume indicator lights green when the volume level becomes greater than the initial value* of that zone.

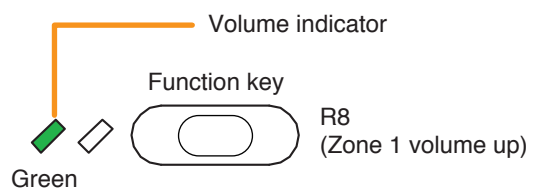

[When decreasing the volume level of the preset zone]

Step: Press the function key R9 (Zone 1 volume down) several times until the volume becomes the desired level.
Each time the key is pressed, the volume level of the set zone or that of the zone pattern decreases by the set amount.
The volume indicator lights green when the volume level becomes smaller than the initial value* of that zone.

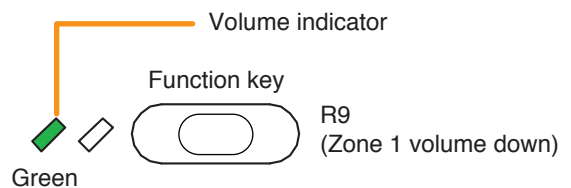

* Volume set in "Sound settings (output)" of the VX-3000 Setting Software.

1.3.8. Example of input volume adjustment

[When increasing the volume level of the preset input channel]

Step: Press the function key 11 (Input 1 volume up) several times until the volume becomes the desired level.
 Each time the key is pressed, the volume level of the set input channel increases by the set amount.
 The volume indicator lights green when the volume level becomes greater than the initial value* of that input channel.

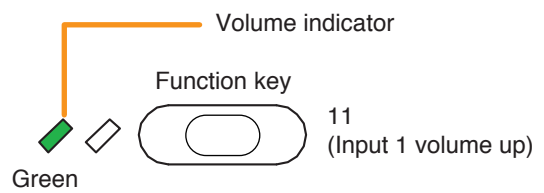

[When decreasing the volume level of the preset input channel]

Step: Press the function key 12 (Input 1 volume down) several times until the volume becomes the desired level.
 Each time the key is pressed, the volume level of the set input channel decreases by the set amount.
 The volume indicator lights green when the volume level becomes smaller than the initial value* of that input channel.

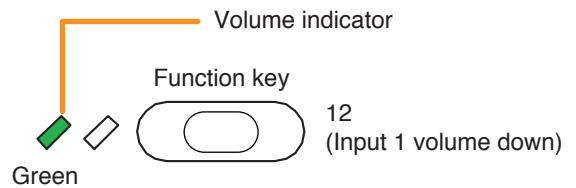

* Volume set in "Sound settings (input)" of the VX-3000 Setting Software.

1.4. Emergency Warning Broadcast

You can start an emergency warning broadcast using the remote microphone's key or the control panel's function key. The preset audio source applied to the VX-3000F's Audio input can be broadcast to the preset zones while the key is held down.

Emergency warning broadcast can be made even during power failure. When attenuators are used in the broadcast zones, the emergency warning broadcast is made bypassing the attenuators and signal processing. When the priority set to the emergency warning broadcast is higher than the emergency broadcast, the emergency warning broadcast will override the emergency broadcast.

When the emergency warning broadcast is activated during general broadcasts, whether the mode remains in normal mode or switches to the emergency mode depends on the "Setting for the mode when activating emergency warning broadcast."

* For details, see the separate setting software instructions, "Emergency Warning Broadcast."

[Operation example for the emergency warning broadcast]

The example below shows the operation procedure when the "Emergency warning broadcast" is assigned to the RM-300X's covered key.

Step 1. Open the cover, then continue to press the Emergency Warning Broadcast key.

The emergency warning broadcast continues and the Emergency warning broadcast indicator lights red while the key is held down.

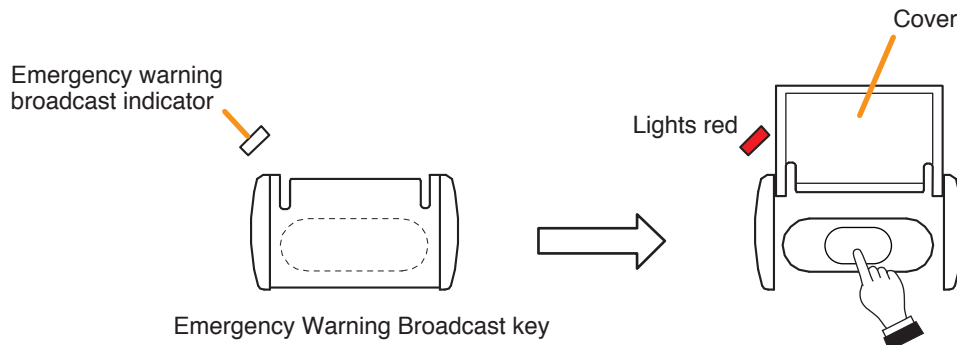

Step 2. Release the Emergency Warning Broadcast key, then close the cover.

The emergency warning broadcast is terminated and the Emergency warning broadcast indicator will go out.

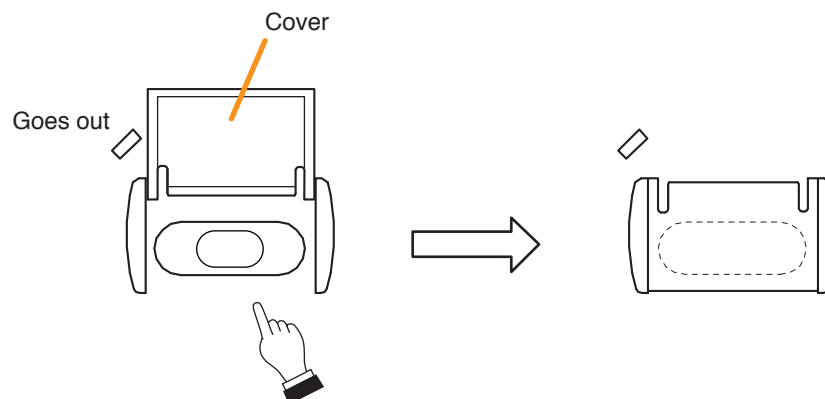

2. OPERATION OF THE RM-500

2.1. Selecting Items on the LCD Screen

A list of pre-registered functions is displayed on the RM-500's LCD screen.

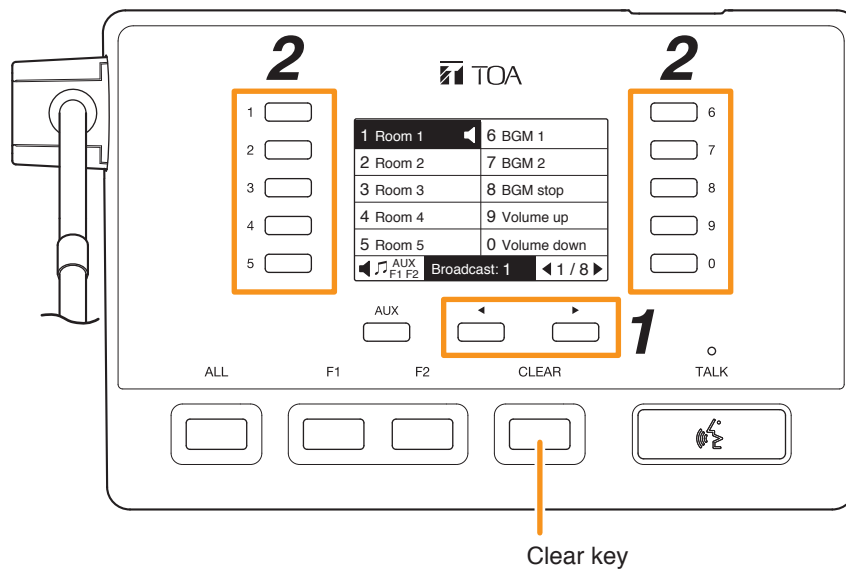

Step 1. Press the ◀ or ▶ key several times to display the page containing the target item to select.

Step 2. Press the numeric key corresponding to the number of the item to select.

Step 3. To continue selecting, repeat Steps 1 and 2 as many times as necessary.

Tips

- To cancel the selection individually, press the numeric key corresponding to the number of the selected item again.
- If the "Clear pre selected zones" function is assigned to the Clear key, pressing the Clear key cancels selections of all zones. For function assignment, refer to "RM Event Setting" in the separate Software instruction manual.

2.2. Making Microphone Announcements

2.2.1. When making the microphone announcements by selecting the broadcast zone(s)

Step 1. Select the broadcast zone(s).

1-1. When making broadcast by selecting the individual zone(s) or pattern
Select the zone(s) from the function list displayed on the LCD screen. (See "[Selecting Items on the LCD Screen](#)" on p. 3-10.)

1-2. When making broadcast to the zones assigned to the ALL key
Press the ALL key.

Tip

The ALL key can be assigned the zone selection of "Pattern or individual."

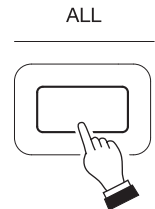

Step 2. Start the microphone announcements.

Press the Talk key. (Microphone announcements start)

When the Talk key is set to PTT type, start microphone announcements holding down the key.

When it is set to Lock type, press the key once, then release the key to start microphone announcements.

When the start chime has been set, the set chime sounds simultaneously when the Talk key is pressed.

While the chime is sounding, a chime icon is displayed in the Chime display area on the LCD screen.

When the Talk indicator turns ON, the microphone announcements becomes available.

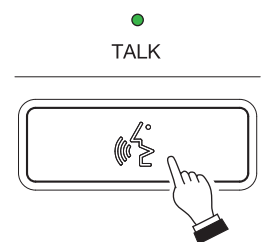

Step 3. Terminate the microphone announcements.

Release the Talk key when it is of PTT type.

Press the Talk key again when it is of Lock type. (End of the microphone announcements)

The broadcast is terminated.

When the end chime has been set, the chime sounds on termination of the broadcast.

Step 4. Cancel the selection of the broadcast zone(s).

When the Zone selection collective clear function has been assigned to the Clear key, press it.

If the said function is included in the function list on the LCD screen, select its corresponding number. (See "[Selecting Items on the LCD Screen](#)" on p. 3-10.)

Zone selection is canceled.

2.2.2. Example of microphone announcements made to the preset zones

You can make broadcasts from the remote microphone to the preset zones only by pressing the Talk key if you assign the broadcast zone pattern or individual zone to the Talk key in advance.

Step 1. Start the microphone announcements.

Press the Talk key. (Microphone announcements start)

When the Talk key is set to PTT type, start microphone announcements holding down the key.

When it is set to Lock type, press the key once, then release the key to start microphone announcements.

When the start chime has been set, the set chime sounds simultaneously when the Talk key is pressed.

While the chime is sounding, a chime icon is displayed in the Chime display area on the LCD screen.

When the Talk indicator turns ON, the microphone announcements becomes available.

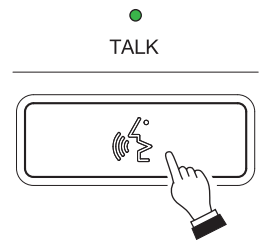

Step 2. Terminate the microphone announcements.

Release the Talk key when it is of PTT type.

Press the Talk key again when it is of Lock type. (End of the microphone announcements)

The broadcast is terminated.

When the end chime has been set, the chime sounds on termination of the broadcast.

2.3. Making Microphone Announcements in Direct Selection Mode

When set to the Direct selection mode, the selection method of the broadcast zones changes as described below.

Direct mode	00-00
Registered zones	
AUX F1 F2	Regist ↓

Input number field

Direct mode	11-02
Registered zones	
AUX F1 F2	Regist ↓

Registered number

Direct mode	00-00
Registered zones	
11-02	
AUX F1 F2	Regist ↓

Step 1. Press the numeric key to enter the line number for which you wish to make broadcast.

The line number is represented by the VX-3000F's ID number and zone number.

For example, for zone 2 of the VX-3000F with ID:11, enter "1102".

The entered line number is displayed in the input number field at the upper right of the screen.

Step 2. Press the ► key to register.

Tip

If you press the Reset/Clear key while the number you are entering is displayed, it is cleared.

The entered line number is registered as the broadcast zone, and the input number field returns to the initial value "00-00".

However, if the specified line cannot be selected because it is busy by the broadcast being made at another unit, the line number is not added to the registered zone and only the input number field returns to the initial value "00-00".

Step 3. To make announcements to multiple lines, repeat **Steps 1 and 2.**

Up to 80 broadcast destinations can be specified.

Tip

To delete the registered line, enter the target line number again, then press the ► key.

Tips

- Up to 30 registered lines can be displayed per page on the LCD screen.

When the number of the lines exceeds 30, the indication "Next page" is displayed in the lower center of the screen.

In this case, press the ◀ key to switch the displayed page.

- This function applies to both the microphone announcements and the AUX broadcast. However, except only the zone selection method by this function, the method to use the Talk key and the AUX key is the same as in the case of "When making the microphone announcements by selecting the broadcast zone(s)" on p. 3-11, and "When the general/BGM broadcast is assigned to the AUX key" on p. 3-14.

Broadcast to the entire zone area can be made using the ALL key.

01-11, 02-02, 07-09, 08-10, 12-01		
30-07, 32-10, 23-09, 06-12, 09-05		
AUX F1 F2	Next ↓	Regist ↓

2.4. Making the AUX Broadcast

When the AUX key is assigned the general broadcast pattern that uses the own unit's AUX input as audio source or the general/BGM broadcast, you can make broadcast the audio signals applied to the AUX input. If the AUX key is set active, the indication "AUX" is displayed in the AUX display area on the LCD screen.

Note

The microphone announcements cannot be made while making the AUX broadcast. If the microphone announcements are set to a higher priority than the AUX broadcast, the general broadcast pattern set to the AUX key is terminated when the microphone announcements start.

2.4.1. When the general pattern broadcast is set to the AUX key

Step 1. Press the AUX key.

The general broadcast pattern assigned to the AUX key is activated. The indication "AUX" in the AUX display area changes highlighted, broadcasting the audio signals from the AUX input to the zones set in the general pattern.

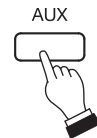

Step 2. To terminate the broadcast, press the AUX key again.

The broadcast from the AUX input is terminated. The indication "AUX" in the AUX display area returns to the original display.



2.4.2. When the general/BGM broadcast is assigned to the AUX key

Step 1. Select the broadcast zone(s).

- 1-1. When making broadcast by selecting the individual zone(s) or pattern
Select the zone(s) from the function list displayed on the LCD screen. (See ["Selecting Items on the LCD Screen"](#) on p. 3-14.)
- 1-2. When making broadcast to the zones assigned to the ALL key
Press the ALL key.

Tip

The ALL key can be assigned the zone selection of "Pattern or individual."

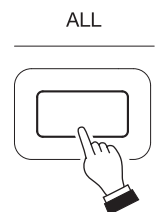

Step 2. Press the AUX key.

The indication "AUX" in the AUX display area changes highlighted, broadcasting the audio signals from the AUX input to the selected zones.



Step 3. To terminate the broadcast, press the AUX key again.

The broadcast from the AUX input is terminated. The indication "AUX" in the AUX display area returns to the original display.



2.5. Activating Various Functions

The functions shown below can be set as selectable items on the LCD screen.

Activate general broadcast pattern, Activate base broadcast pattern, Interrupt base broadcast pattern, Zone volume adjustment (Pulse), Input volume adjustment (Pulse), Emergency warning broadcast, RM broadcast status, Activate general/BGM broadcast, Pre select (Pattern), Pre select (Individual), Clear pre selected zones, Intended control input operation, Intended control output operation (Pulse), Intended control output operation (Level), Power on

In addition, you can set the specific functions shown below to each of the following keys.

ALL key: Pre select (Pattern), Pre select (Individual)

Clear key: Clear pre selected zones

AUX key: Activate general broadcast pattern*¹, Activate general/BGM broadcast*¹

*¹ The audio source that can be used for the broadcast activated with the AUX key is limited to the AUX input of the own unit.

In the case of the RM-500, the functions are selected by using the LCD screen or the ALL key, the Reset/Clear key, and the AUX key.

Except for that, the RM-500 is the same in how to use the functions as other remote microphones such as RM-200SF and RM-300X.

Activate general broadcast pattern: See ["Example of general broadcasting"](#) on p. 3-6.

Activate base broadcast pattern, Interrupt base broadcast pattern:

See ["Example of BGM broadcasting"](#) on p. 3-6.

Zone volume adjustment (Pulse)*²: See ["Example of zone volume adjustment"](#) on p. 3-7.

Input volume adjustment (Pulse)*²: See ["Example of input volume adjustment"](#) on p. 3-8.

Emergency warning broadcast: See ["Emergency Warning Broadcast"](#) on p. 3-9.

Activate general/BGM broadcast: See ["Example of general/BGM broadcasting"](#) on p. 3-7.

Intended control input operation: See ["Intended Control Input Operation"](#) on p. 3-37.

Intended control output operation (Pulse): See ["Intended Control Output Operation \(Pulse\)"](#) on p. 3-37.

Intended control output operation (Level): See ["Intended Control Output Operation \(Level\)"](#) on p. 3-38.

RM broadcast status*³: See ["Indicator State at the Time of RM Broadcast Status Display"](#) on p. 2-68.

Power on: See ["Switching VX-3000 Amplifier's Power State between Active \(ON\) and Sleep Modes"](#) on p. 3-39.

*² When you perform the volume adjustment operation, the volume level is displayed on the LCD screen for about 3 seconds as shown in the figure below.

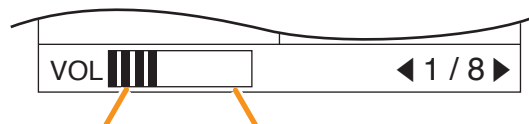

Current level is shown by the number of vertical bars.

Reference level is shown by the frame.

*³ Function for display only

Each function of the Zone selection (pattern), the Zone selection (individual), and the Zone selection collective clear is as described on [p. 3-11 "Making Microphone Announcements"](#) and [p. 3-14 "Making the AUX Broadcast."](#)

2.6. Locking Keys

You can use the Key lock function when you set the Key lock function to "Use." (See the separate Installation Manual, "Setting The RM-500's Menu.")

By locking the key, you can disable other operations than the key unlock operation. The indication "Key lock" is displayed on the LCD screen during key lock.

1 Room 1	6 BGM 1
2 Room 2	7 BGM 2
3 Room 3	8 BGM stop
4 Room 4	9 Volume up
5 Room 5	0 Volume down
AUX F1 F2	◀ 1 / 8 ▶

Tip

The key lock state continues even if the power supply is stopped.

2.6.1. When locking the key

Step: When the indication "Key lock" is not displayed, press and hold the ◀ or ▶ keys simultaneously until the indication "Key lock" is displayed.

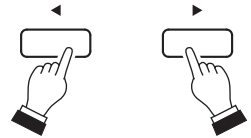

2.6.2. When unlocking the Key lock

Step: When the indication "Key lock" is displayed, press and hold the ◀ or ▶ keys simultaneously until the indication "Key lock" disappears.

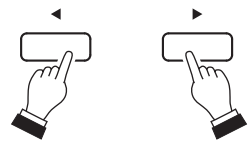

3. EMERGENCY BROADCAST

3.1. Typical System Examples

Here, an example of sequential operation with the VX-3000 system is explained.

[Sequential Operation]

Sequential operation consists of Phase 1 and Phase 2.

Sequence Phase 1 operates upon emergency system activation. When the set time interval elapses, the broadcast is automatically switched to Phase 2.

[Setting Contents]

Both the broadcast messages and output zones are set for Phase 1 and Phase 2.

Assuming that these phases are set as follows:

Phase 1: The alert message is continuously broadcast for 5 minutes to each floor of each building.

Phase 2: The evacuation message is continuously broadcast to the entire zone.

[Alert and Evacuation Message Examples]

Alert Message: The fire alarm system has been engaged. We are now checking the cause. Please wait for further information.

Evacuation Message: There is a fire. Please evacuate immediately.

Step 1. Background music (BGM) is broadcast to A-GF (Building A ground floor) and B-GF (Building B ground floor) when the system is in general-purpose broadcast mode.

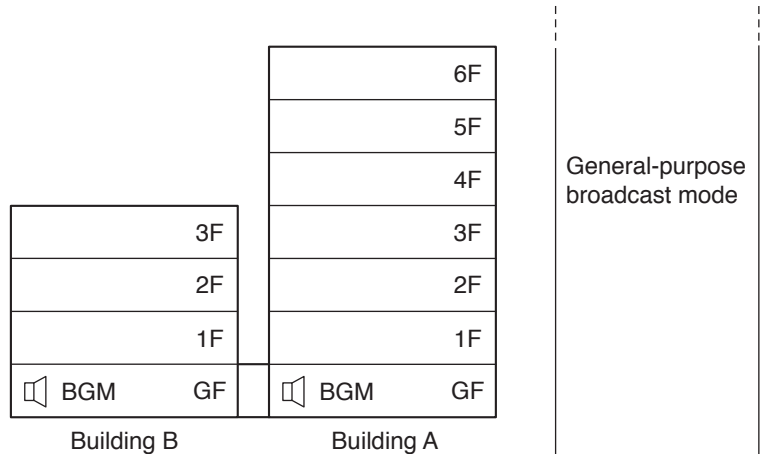

Step 2. The sensor installed on A-3F detects irregularities, and the fire alarm system transmits a control signal to the control input. The emergency mode is activated, allowing the alert message to be played through to A-3F.

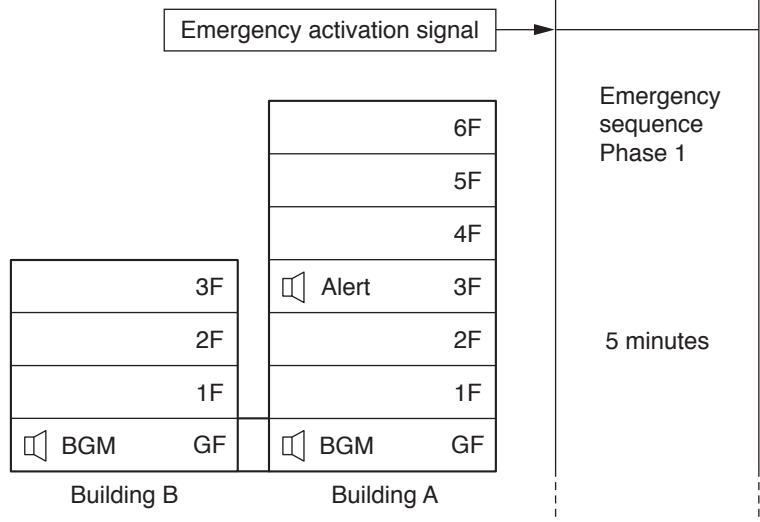

Step 3. Following this, the sensors installed on A-2F and A-4F detect irregularities and the fire alarm system transmits a control signal to the control input. Broadcast zones are added, and the alert message is also broadcast to A-2F and A-4F, as well.

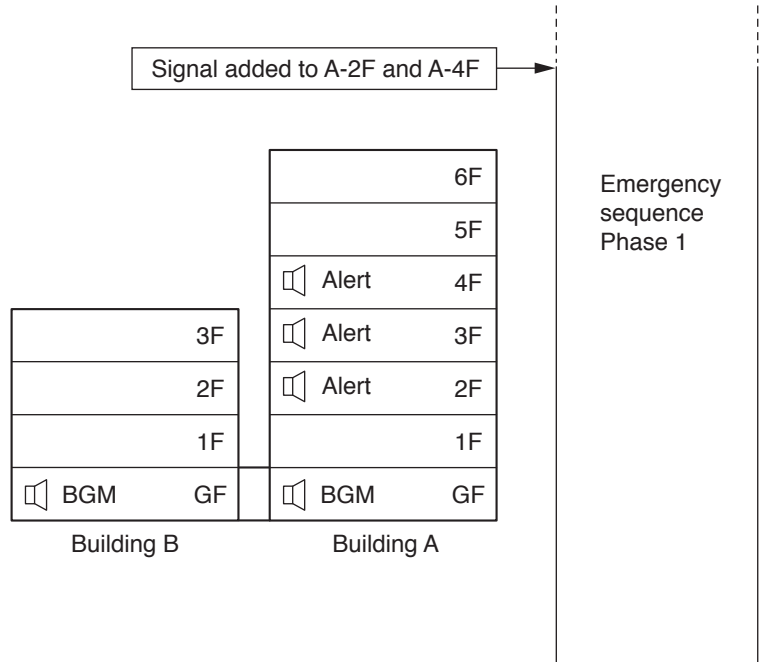

Step 4. After the set 5-minute time interval elapses, the message is automatically switched from Phase 1 to Phase 2. Broadcast zones change to the "entire zone" and the evacuation message is broadcast to the entire area, and BGM stops. The evacuation announcement continues until the Remote Microphone's Reset key is pressed or a restoration signal is transmitted from the connected fire alarm system.

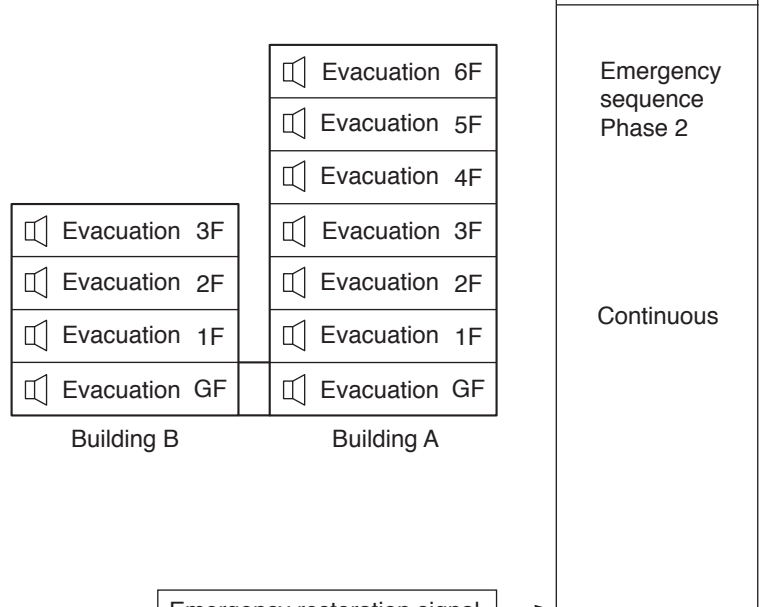

Step 5. The fire alarm system transmits a restoration control signal to the control input. The emergency mode is terminated and the broadcast reverts to general-purpose broadcast mode, restoring BGM output.

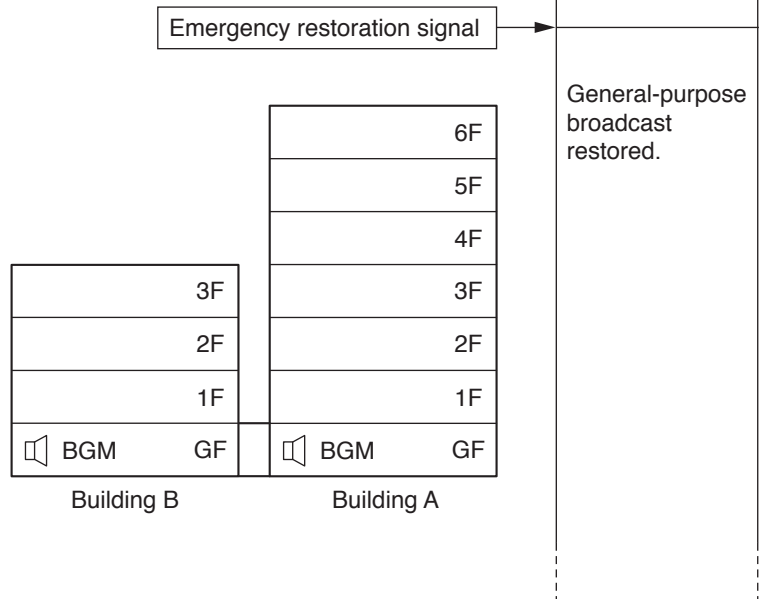

3.2. Remote Microphone Operation Example

The emergency mode can be activated and restored not only from the connected fire alarm system, but also from any Remote Microphone set for emergency or emergency/general-purpose operation.

Here, the settings of the Fireman's Microphone RM-200SF installed on GF of Building A are used as an example to explain the flow from emergency mode activation to its restoration.

[Setting Contents of Fireman's Microphone]

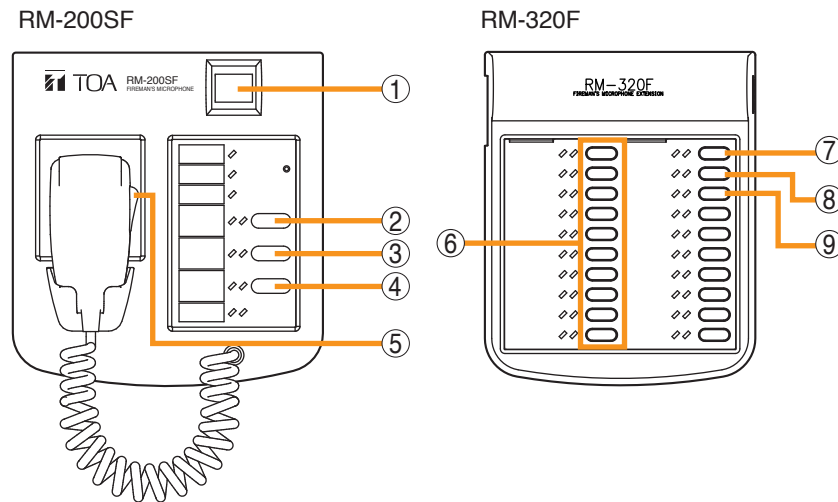

Key	Setting	Function
(1)	Emergency Broadcast Pattern Start	Activates emergency mode and recalls emergency sequence patterns. [Pattern contents] Phase 1: Alert message; all zones; 5 minutes Phase 2: Evacuation message; all zones; continuous
(2)	Emergency Sequence Phase Shift	Shifts the phase of the sequence pattern currently being broadcast to the next phase.
(3)	Emergency Reset (Restoration message)	Broadcast is restored from emergency to normal (general-purpose) broadcast mode after Restoration message announcement completion.
(4)	All-Zone Call	Selects all zones.
(5)	Press-to-Talk	Makes microphone announcements.
(6)	Zone Selection	Selects individual zone or zone pattern.
(7)	Emergency EV Broadcast	Broadcasts Alert message.
(8)	Emergency Acknowledge	Receives the emergency acknowledge and stops the buzzer sound.
(9)	Disablement of EMG control from CIN	Disables emergency activation from the control input.

For instructions on assigning functions to function keys, see the separate Setting Software Instructions, "EVENT SETTINGS."

[Operation example 1]

Described below are the steps of system operation from emergency mode activation to restoration.

Step 1. Press the Emergency key (1).

- Emergency mode is activated and the Emergency key lights red.
- The pre-configured emergency sequence pattern is recalled, and the Alert Message is broadcast to all zones.
- The Zone monitor indicator of the All-Zone Call key (4) indicates the type of message currently being broadcast. It flashes red to indicate that an alert message is currently being broadcast.

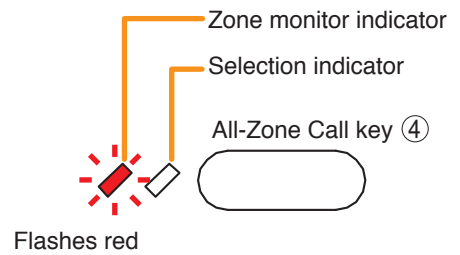
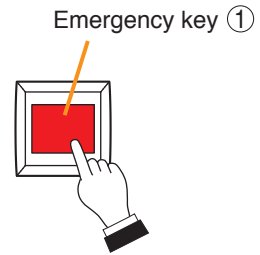

- The Phase state indicator of the Emergency Sequence Phase Shift key (2) lights green when the emergency sequence phase 1 is broadcast.

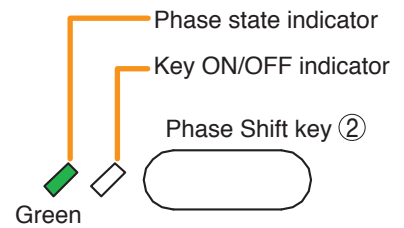

Step 2. Press the Emergency Phase Shift key (2) to broadcast the Evacuation message, if necessary. (If the unit is placed in idle state for 5 minutes, the message will automatically switch from the current message to the evacuation message by the Emergency sequence function.)

The Evacuation message will be broadcast to all zones. In this event, the broadcast pattern shifts from the emergency sequence phase 1 to the phase 2, and the Phase state indicator flashes green.

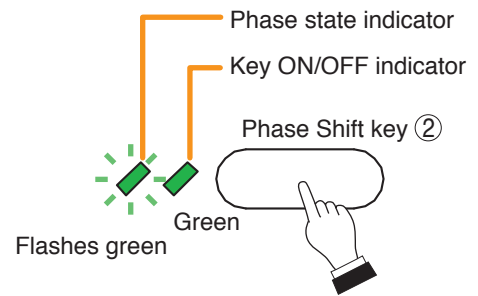

The Zone monitor indicator of the All-Zone Call key (4) indicates the type of message currently being broadcast. It changes from flashing red to steady red status to indicate that the evacuation message is being broadcast.

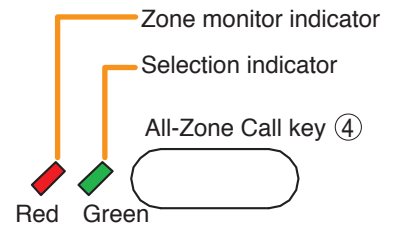

Step 3. When making broadcast using the RM-200SF, follow the procedures below.

- Press the All-Zone Call key (4) to select all zones. In this event, the Selection indicator lights.

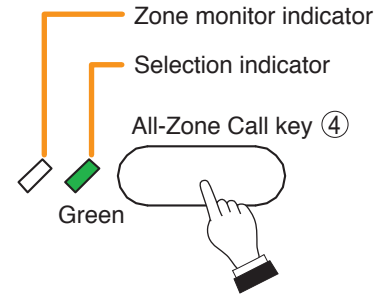

- Press the Talk key (5), then make voice announcements to all zones. In this event, the Broadcast status indicator lights yellow, and the Microphone indicator lights green.

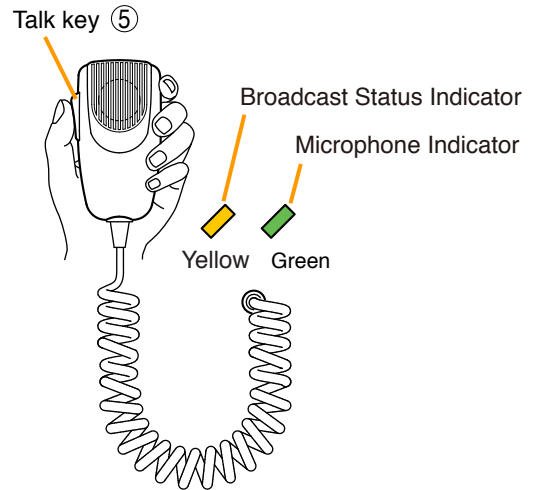

Also, the Zone monitor indicator of the All-Zone Call key (4) lights yellow.

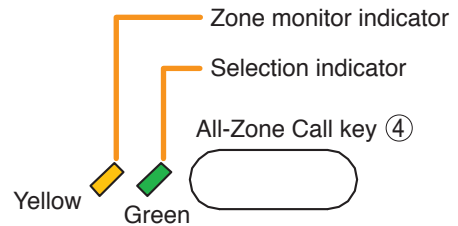

Tip

When a Fireman's Microphone announcement interrupts a message broadcast, the broadcast mode that follows Fireman's Microphone announcement completion can be set to either "Continue" for continuous EV message broadcast or "Silent" for broadcast termination. This setting can be made by using the VX-3000 Setting Software.

Step 4. Terminate the Emergency status.

Press the Emergency Reset key (3). The restoration message is broadcast to the entire zone, and the Restoration EV message status indicator of the Emergency Reset key (3) lights while the message is broadcast. After the message broadcast completion, the VX-3000 system is restored from Emergency status to the General-purpose broadcast status, and the Emergency status indicator (1) built in the Emergency key goes off.

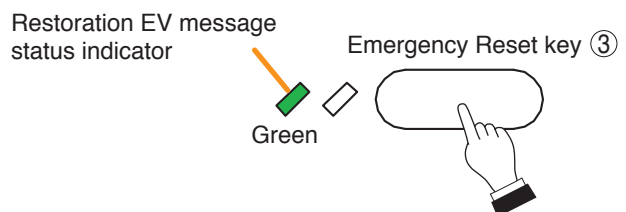
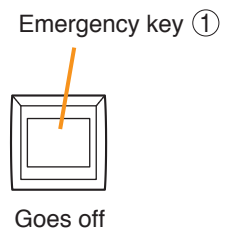

[Operation example 2 (Example of emergency EV broadcasting)]

When the system is in emergency mode, an emergency EV message can be broadcast to the zones after you designate them.

Note

It is not possible to broadcast the Emergency EV message even if the operation below is executed during general mode.

- Step 1.** Select the zone(s) to broadcast.
Press one or more zone selection keys.
The selection indicator to the left of the pressed key lights.

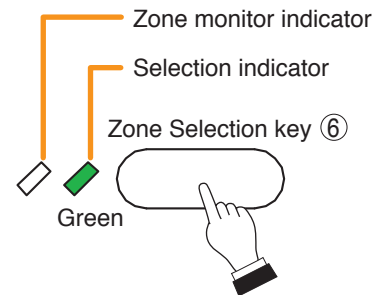

- Step 2.** Press the Emergency EV Broadcast key.
Emergency EV message is broadcast to the selected zones.
The Key ON/OFF indicator of the Emergency EV Broadcast key lights green, and the Emergency EV broadcast status indicator lights red.

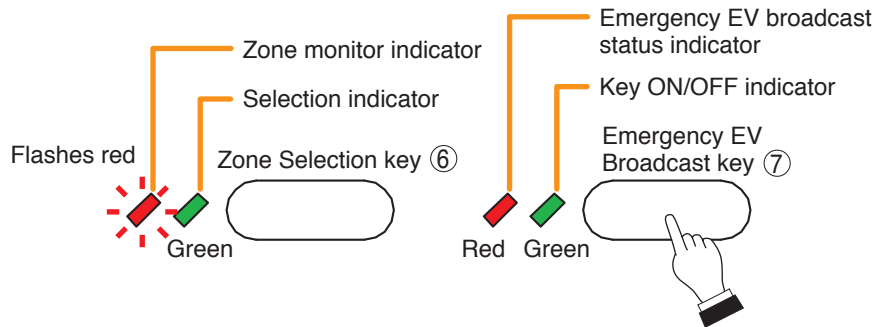

[Operation example 3 (Example of emergency acknowledge)]

When the emergency broadcast pattern is activated, the buzzer built in the remote microphone sounds and the Emergency broadcast status indicator to the left of the Emergency acknowledge key flashes red.

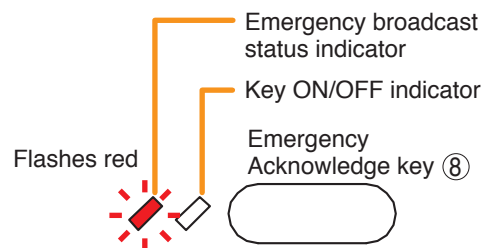

- Step:** Press the Emergency Acknowledge key.
The buzzer stops sounding.
The Key ON/OFF indicator of the Emergency Acknowledge key lights green, and the Emergency broadcast status indicator lights red.

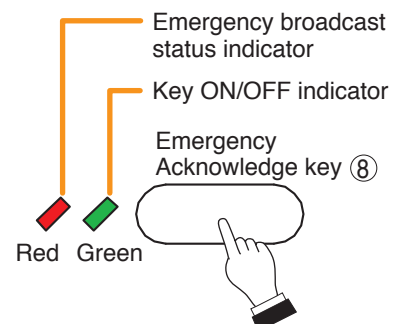

(The Key ON/OFF indicator lights only when the key is pressed.)

[Operation example 4 (Example of disablement of EMG control from CIN: Basic operation)]

You can stop the emergency activation from the control input when the system is in general mode. This function is intended not to activate the emergency broadcast by the fire alarm system during maintenance.

Note

This function is enabled only when the system is in general mode. Even if you press the key to which this function is assigned while the system is in emergency mode, a beep tone will sound, making the operation invalid.

Step 1. Press the "Disablement of EMG control from CIN" key while the system is in general mode.

The key ON/OFF indicator lights green and the status indicator of "disablement of EMG control from CIN" function lights red.

In this condition, the emergency activation becomes invalid even if the emergency broadcast pattern is activated by way of the control input.

When a warning buzzer notifying that this function is being left ON is set, a beep tone will sound once every 10 seconds at the remote microphone where the operation is performed.

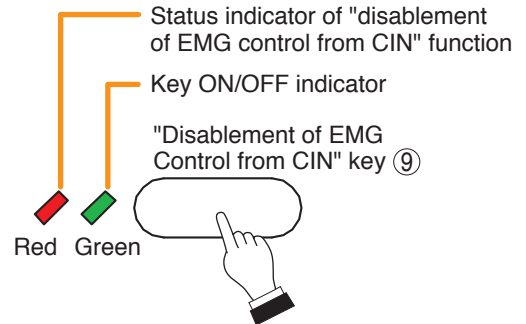

Step 2. Press the "Disablement of EMG control from CIN" key again.

The key ON/OFF indicator and the status indicator of "disablement of EMG control from CIN" function go off.

If the beep tone is sounding at the remote microphone, it will stop.

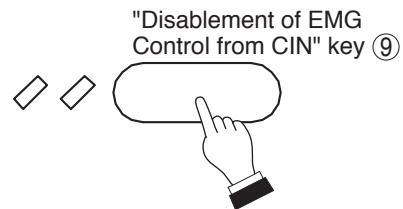

[Operation example 5 (Example of disablement of EMG control from CIN: Operation when the function is turned ON by other remote microphone)]

When the "Disablement of EMG control from CIN" key is assigned to 2 or more remote microphones' function keys, the buzzer will sound and the status indicator of "disablement of EMG control from CIN" function will flash red if this function is turned ON by other remote microphone.

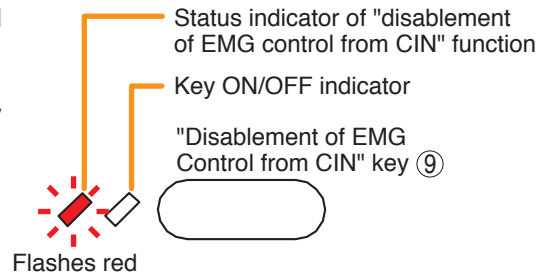

Step 1. Press the "Disablement of EMG control from CIN" key when the buzzer sounds. The status indicator of "disablement of EMG control from CIN" function lights red. When a warning buzzer notifying that this function is being left ON is set, a beep tone will sound once every 10 seconds at the remote microphone where the operation is performed.

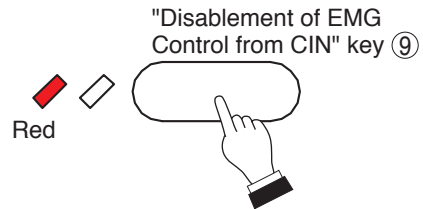

Step 2. Press the "Disablement of EMG control from CIN" key again. The key ON/OFF indicator lights green. If the beep tone is sounding, it will stop only at the remote microphone where the operation is performed. The status indicator of "disablement of EMG control from CIN" function remains lit red as long as this function is kept ON by other remote microphone. The status indicator of "disablement of EMG control from CIN" function goes off when the function is turned OFF by all the remote microphones to which this function is assigned.

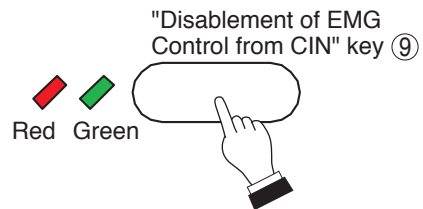

Note

The emergency activation from the control input is kept invalid unless this function is turned OFF by all the remote microphones to which this function is assigned.

4. MAKING ALL-ZONE EMERGENCY BROADCAST

If normal broadcasts cannot be made due to system failure or some trouble, only an all-call is possible.

This is a broadcast made by bypassing the CPU* that normally operates in the VX-3000 system. (For details, see the separate Installation Manual, "INSTALLATION AND SETTING PROCEDURES.")

This broadcast is called "All-zone emergency broadcast."

All-zone emergency broadcast can be made by operating the DIP switch of the RM-300X or RM-200SF independently of settings performed using the VX-3000 Setting Software. (For operations of the RM-300X, see p. 3-26. For operations of the RM-200SF, see p. 3-27.)

* CPU is a central processing unit, which is built in the VX-3004F, VX-3008F, and VX-3016F.

4.1. Priority Control of the All-Zone Emergency Broadcast

In the All-zone emergency broadcast, how the priority control operates depends on the destination to which the RM-300X or RM-200SF is connected regardless of the priority setting made on the VX-3000 Setting software.

The relationship between the priority order and the connection destination is described below.

When broadcasts with the same priority overlap, they are mixed and output.

Connection destination with the highest priority: RS LINK A terminal of the VX-3000F set to ID "0"

Connection destination with 2nd highest priority: RS LINK B terminal of the VX-3000F set to ID "0"

Connection destination with 3rd highest priority: RS LINK A and B terminals of the VX-3000F set to ID other than "0"

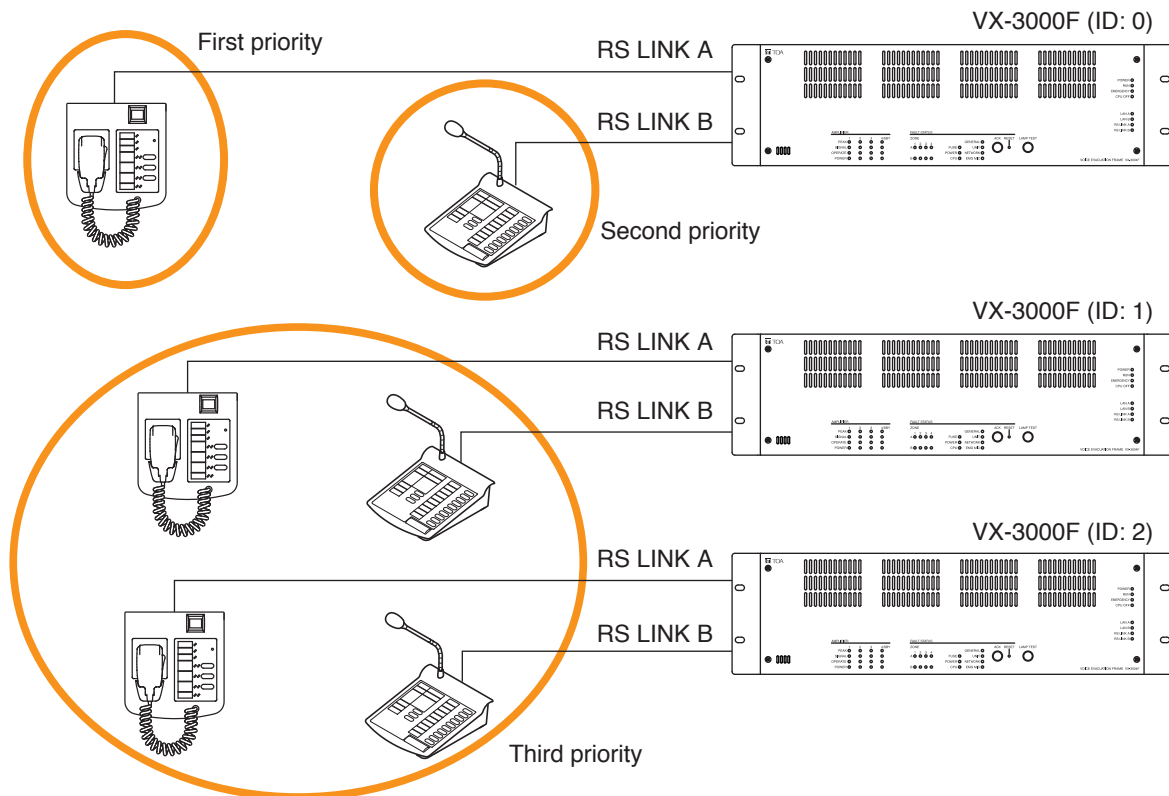

Following are operations when you activate a remote microphone to make broadcast.

- When broadcast from the remote microphone with higher priority is in progress, your broadcast cannot be made.
- When broadcast from the remote microphone with the same priority is in progress, your broadcast is mixed with the current broadcast in progress.
- When broadcast from the remote microphone with lower priority is in progress, your broadcast overrides the current broadcast in progress. When the overridden broadcast still continues after your broadcast is complete, it will resume.

Note

Never make All-zone emergency broadcast simultaneously using 2 or more Remote microphones connected to the same RS LINK connector.

Doing so may reduce broadcast sound volume and broadcast will not be made normally.

4.2. Making All-zone Emergency Broadcast from the RM-300X

Open the cover of the All-zone Emergency Broadcast key, then while holding down the key, wait about 4 seconds until the Failure indicator lights red and begin to make microphone announcements.

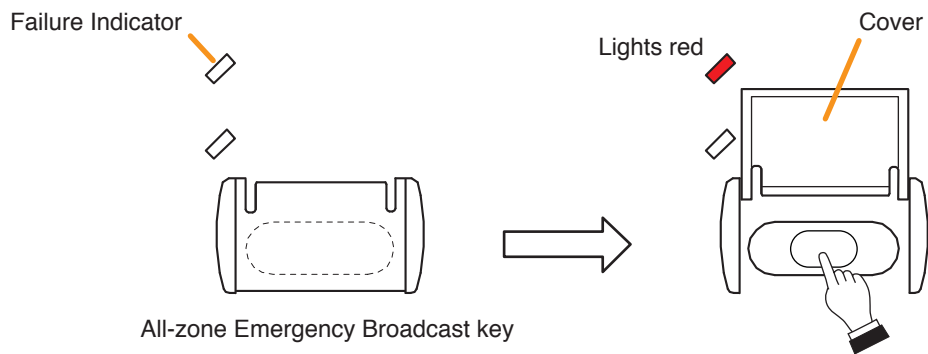

Notes

- The RM-300X's DIP switch 5 (factory default: ON) must be preset to ON to enable the CPU OFF function (all-zone emergency broadcast).
- The event being activated from the remote microphone will be cleared when the system is placed in the CPU OFF state, and not restarted when its state is released.

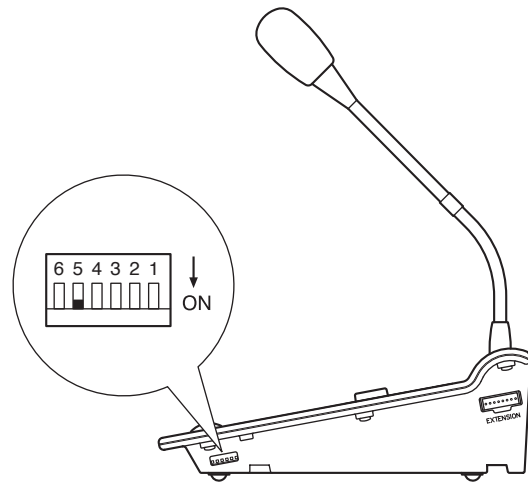

4.3. Making All-zone Emergency Broadcast from the RM-200SF

Step 1. Set the CPU switch on the front surface to OFF.

Tip: The CPU switch is factory-preset to ON.

RM-200SF front

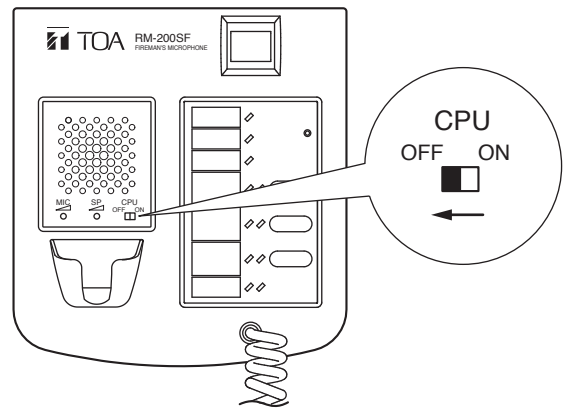

Notes

- The RM-200SF's DIP switch 6 (factory default: ON) must be preset to ON to enable the CPU OFF function (all-zone emergency broadcast).
- The event being activated from the remote microphone will be cleared when the system is placed in the CPU OFF state, and not restarted when its state is released.

RM-200SF rear

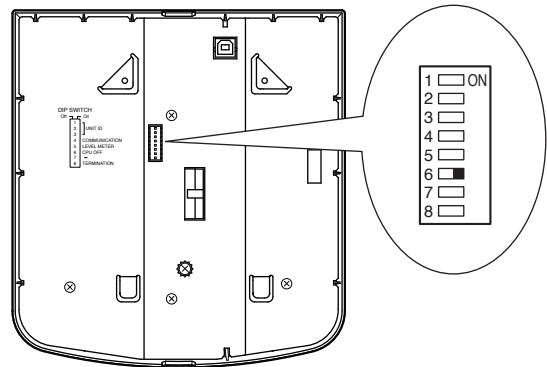

Step 2. Make the microphone announcement while holding down the Talk key.

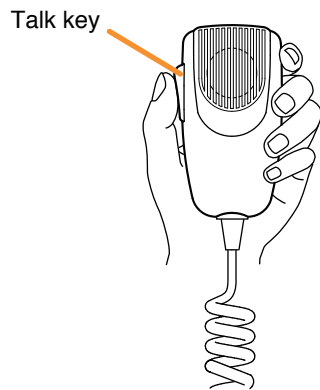

Step 3. When the microphone announcement is complete, return the CPU switch to ON.

5. DETECTING FAULT

If a malfunction occurs within the VX-3000 system, the fault state can be indicated, acknowledged or reset using the following keys or control terminals.

- FAULT ACK and FAULT RESET keys on the VX-3004F, VX-3008F, and VX-3016F
- Control input terminals of the VX-3004F, VX-3008F, and VX-3016F
- Function keys on the RM-300X or RM-200SF

Note

Regarding the setting procedures for detecting fault within the VX-3000 system, see the separate Setting Software Instructions, "BASIC SETTINGS."

5.1. Fault Detection Setting Example

The method to detect the fault within the system using the VX-3004F, RM-200SF, and RM-320F is described below.

[System configuration]

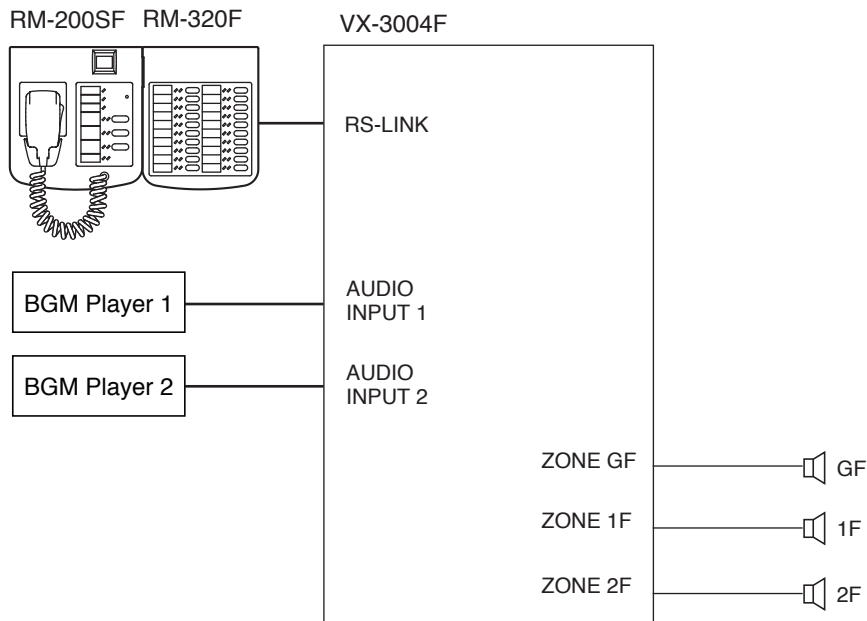

[Remote Microphone's Function key setting]

RM-200SF

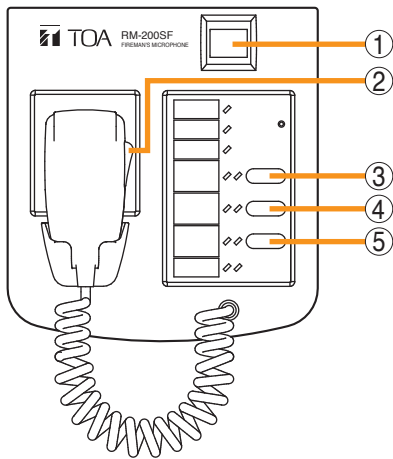

Key	Set function
(1)	(Not set)
(2)	Talk key (fixed)
(3)	Zone Clear
(4)	Failure Output Reset
(5)	Lamp Test

RM-320F

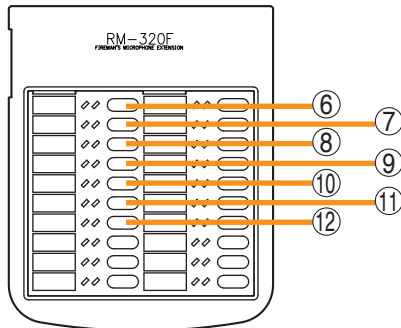

Key	Set function	Contents (failure pattern)
(6)	Failure Output Receipt	VX-3004F
(7)	Failure Output Receipt	Amplifier ZONE GF
(8)	Failure Output Receipt	Amplifier ZONE 1F
(9)	Failure Output Receipt	Amplifier ZONE 2F
(10)	Failure Output Receipt	Speaker ZONE GF
(11)	Failure Output Receipt	Speaker ZONE 1F
(12)	Failure Output Receipt	Speaker ZONE 2F

Notes

- For instructions on assigning functions to function keys, see the separate Setting Software Instructions, "EVENT SETTINGS."
- For instructions on setting failure pattern, see the separate Setting Software Instructions, "PATTERN SETTINGS."

5.2. Case Example of Malfunction

The example here assumes that the speaker terminal for the Zone 2F is disconnected.

VX-3004F

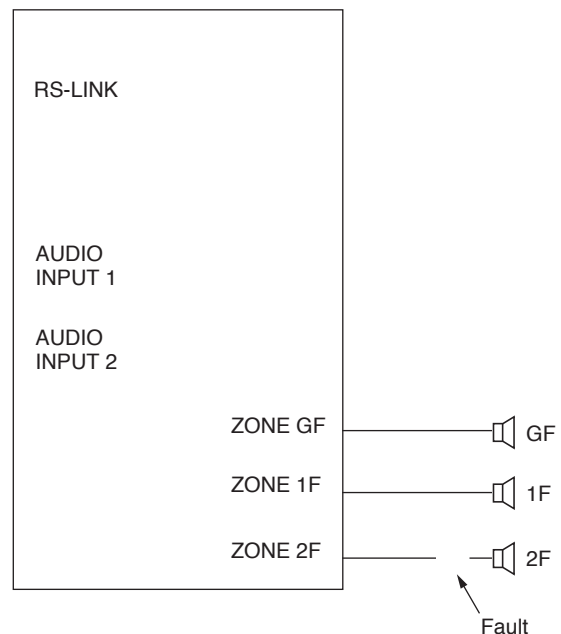

5.3. Remote Microphone's Operation Example

When the failure is detected, the buzzer built in the remote microphone sounds, and the Zone 2F failure output receipt state indicator flashes yellow.

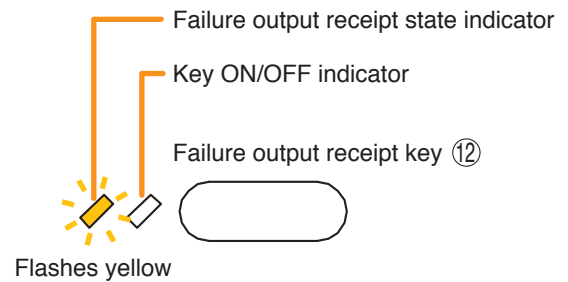

Step 1. Press the Failure output receipt key (12) to acknowledge the failure.

The buzzer stops sounding, and the Failure output receipt state indicator switches from flashing to steady on.

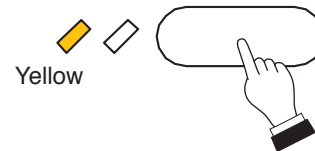

Step 2. Locate the cause, then remove it.

Connect a PC to the VX-3004F and read out the log data using the VX-3000 Setting Software. For details, see the separate Setting Software Instructions, "MAINTENANCE."

Confirm the cause of failure or abnormality on the log data (in this example, the log data that the speaker terminal for the zone 2F is open state is listed), then fix the fault part.

Note

Operation of failure indication differs depending on which the Failure indication setting is set to "Auto reset" or "Manual reset" on the VX-3000 Setting Software.

[When set to "Auto reset"]

For most failure indications, the failure LED automatically goes off when the cause has been corrected. For certain other failure indications, such as power amplifier failure or speaker shorts, the LED does not automatically go off. In such cases, Failure Output Reset key needs to be pressed.

[When set to "Manual reset"]

The failure indication is retained until the Failure output reset key is pressed even when failure is restored.

Step 3. Press the Failure Output Reset key (4).

The Failure output receipt state indicator goes off.

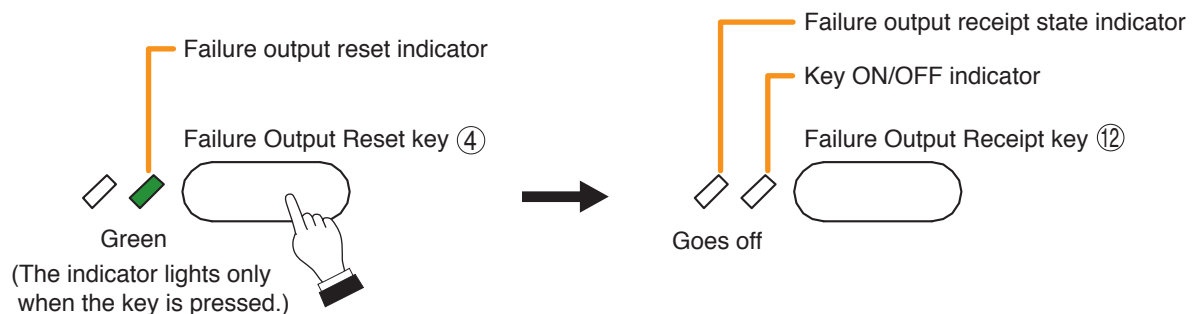

5.4. VX-3004F's Operation Example

When the failure is detected, the built-in buzzer sounds, and the General fault indicator on the front panel flashes.

In the case of the malfunction example on p. 3-29, both the Zone fault indicator 3 and the unit failure indicator corresponding to the fault point flash yellow.

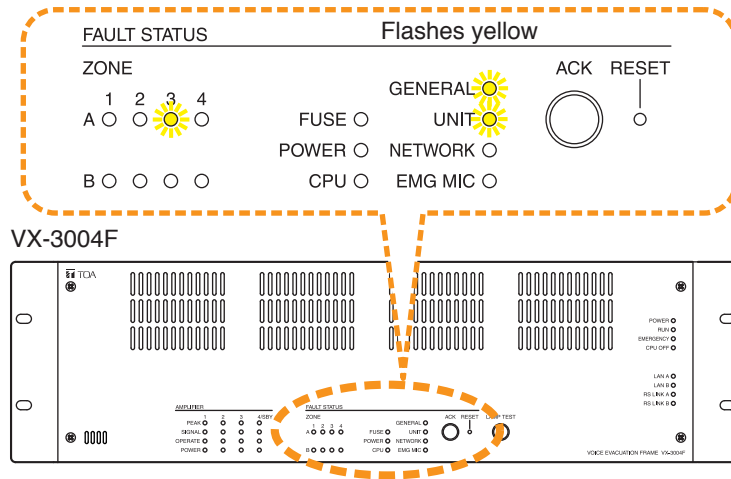

Step 1. Press the Fault ACK key to acknowledge the failure.

The buzzer stops sounding, and the General fault indicator switches from flashing to steady on.

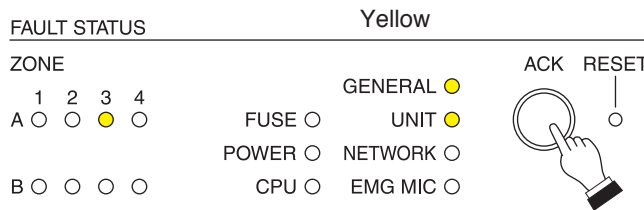

Notes

- When the failure reception function has been assigned to the control input terminal on the rear panel of the VX-3004F, VX-3008F, or VX-3016F, it is also possible to receive a system failure via control input. For details, see the separate Setting Software Instructions, "EVENT SETTINGS."
- It is also possible to receive a system failure by shorting the Control input terminals on the rear panel of the VX-3004F, VX-3008F, or VX-3016F.

Step 2. Locate the cause, then remove it.

Connect a PC to the VX-3004F and read out the log data using the VX-3000 Setting Software. For details, see the separate Setting Software Instructions, "Maintenance."

Confirm the cause of failure or abnormality on the log data (in this example, the log data that the speaker terminal for the zone 2F is open state is listed), then fix the fault part.

Note

Operation of failure indication differs depending on which the Failure indication setting is set to "Auto reset" or "Manual reset" on the VX-3000 Setting Software.

[When set to "Auto reset"]

For most failure indications, the failure LED automatically goes off when the cause has been corrected. For certain other failure indications, such as power amplifier failure or speaker shorts, the LED does not automatically go off. In such cases, Fault reset key needs to be pressed.

[When set to "Manual reset"]

The failure indication is retained until the Failure reset key is pressed even when failure is restored.

Step 3. Press the Fault reset key.

The General fault indicator goes off, and the VX-3000 system returns to normal state.

FAULT STATUS

ZONE

1 2 3 4
A ○ ○ ○ ○

B ○ ○ ○ ○

GENERAL ○
FUSE ○ UNIT ○
POWER ○ NETWORK ○
CPU ○ EMG MIC ○

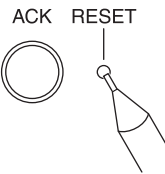

Note
Use a fine-tipped object to press the Fault reset key.

5.5. Example of Executing the Failure Reception and Failure Reset by Way of the Control Input Terminals

Assign the failure reception and failure reset functions to the control input terminals on the rear panel of the VX-3004F, VX-3008F, and VX-3016F in advance.

(For details, see the separate software instruction manual, "EVENT SETTINGS.")

Short each function-assigned terminals with a one-shot pulse.

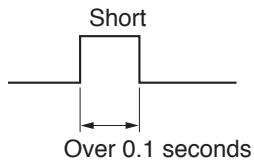

6. LAMP TEST

Operation of audio monitor and control input/output can be performed using the remote microphone's function key.

Functions other than the audio monitor shown in the table below can also be operated with the function keys on the control panel.

6.1. Remote Microphone's Operation Example

[Remote Microphone's Function key setting]

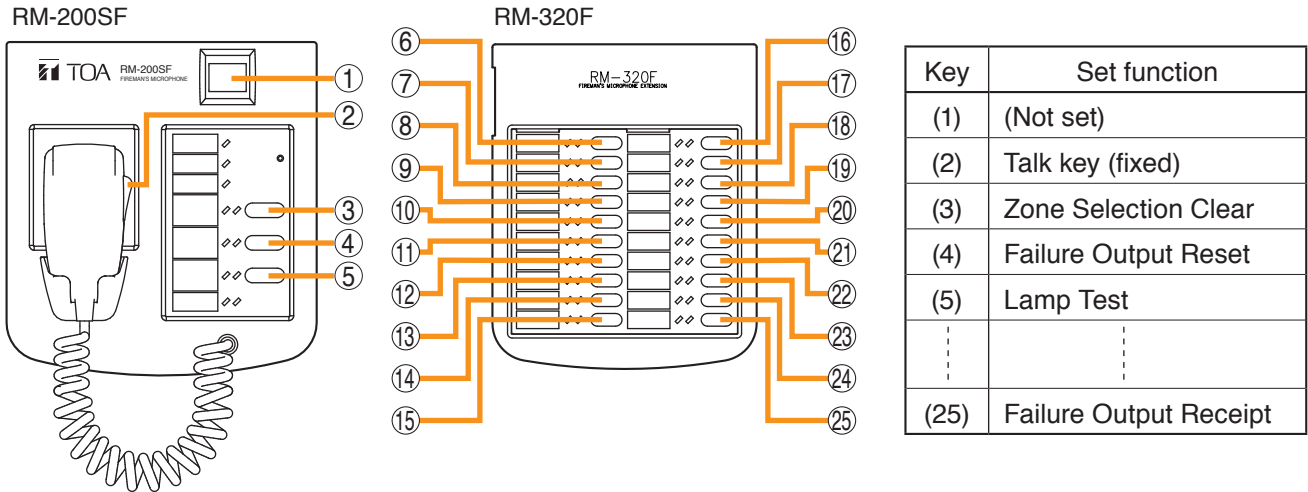

Note

For instructions on assigning functions to function keys, see the separate Setting Software Instructions, "EVENT SETTINGS."

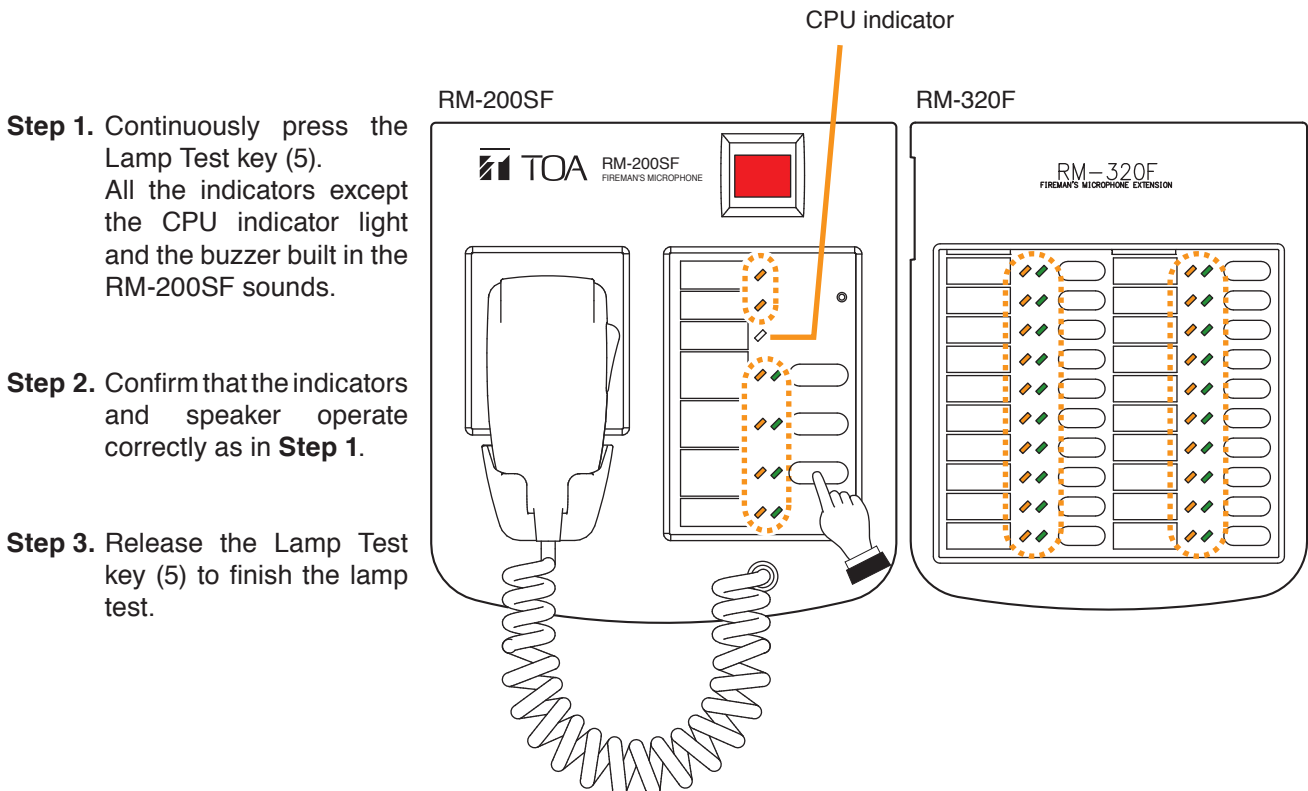

6.2. VX-3004F's Operation Example

Step 1. Continuously press the Lamp test key.

All indicators light, and the buzzer built in the VX-3004F sounds.

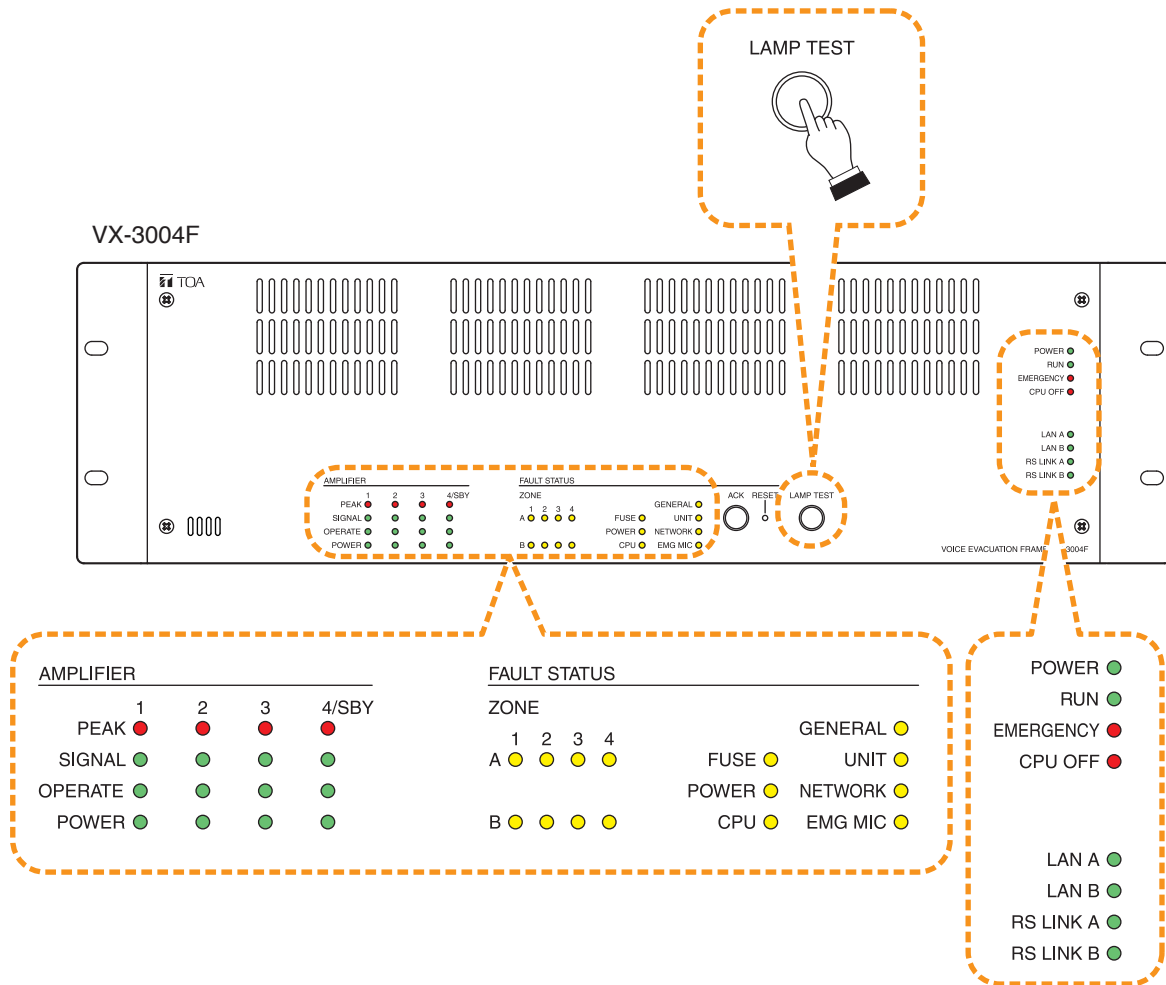

Step 2. Confirm that the indicators and buzzer operate correctly as in **Step 1**.

Step 3. Release the Lamp test key to finish the lamp test.

7. OTHER FUNCTIONS

Operation of audio monitor and control input/output can be performed using the remote microphone's function key.

Functions other than the audio monitor shown in the table below can also be operated with the function keys on the control panel.

[Setting example to function keys of the remote microphone]

Key	Item Name	Function
Function key R7	Audio Monitor	Monitors audio signals being broadcast at an arbitrary zone.
Function key R8	Intended Control Input Operation	Makes the Intended control input Active.
Function key R9	Intended Control Output Operation (Pulse)	Activates the Intended control output pattern.
Function key R10	Intended Control Output Operation (Level)	Activates the intended control output pattern while this key is held down.
Function key L1	Power on	Switches the VX-3000F's amplifier power state between active (ON) and sleep modes.

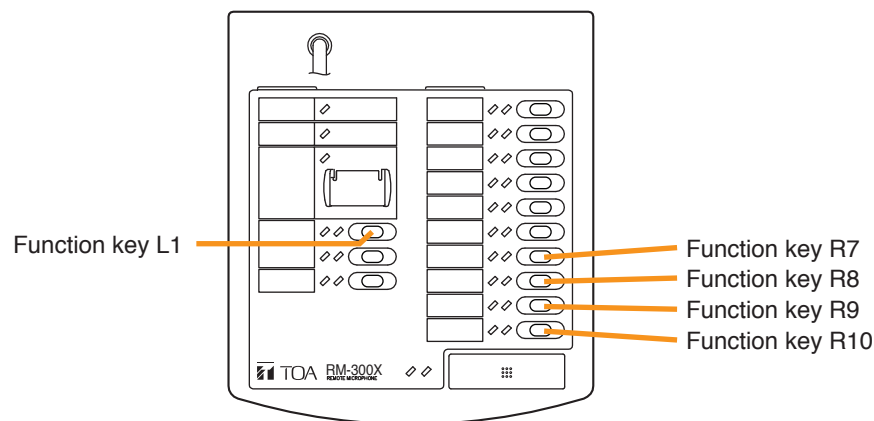

Given here is an operation example using the RM-300X. Its basic operations and displays are the same as for the RM-210F, the RM-200SF, and the RM-320F.

In the case of the VX-3000CT, audio monitoring cannot be made, but other functions can be performed in the same way.

Concerning the RM-500, see [p. 3-10](#) for basic operations and [p. 2-61](#) for displays. However, audio monitoring cannot be made.

7.1. Audio Monitor

Audio signals during broadcast can be monitored by the remote microphone (except the RM-500).

Step 1. Press the Audio monitor key.

The Broadcast status indicator lights green while audio signals are broadcast to the zone assigned to this function key.

Audio signals being broadcast in the zone assigned to the Audio monitor key are output from the remote microphone.

Notes

- No broadcast is output to the zone assigned to the Audio monitor key when the Broadcast status indicator is unlit.
- Only one remote microphone can be used for audio monitoring even when 2 or more remote microphones are connected to a single VX-3000F. Only the remote microphone of which Audio Monitor key is pressed most recently is effective for audio monitoring, causing other remote microphone engaged in monitoring to be interrupted.

Step 2. Press the Audio monitor key again to end monitoring.
The Broadcast status indicator will go off.

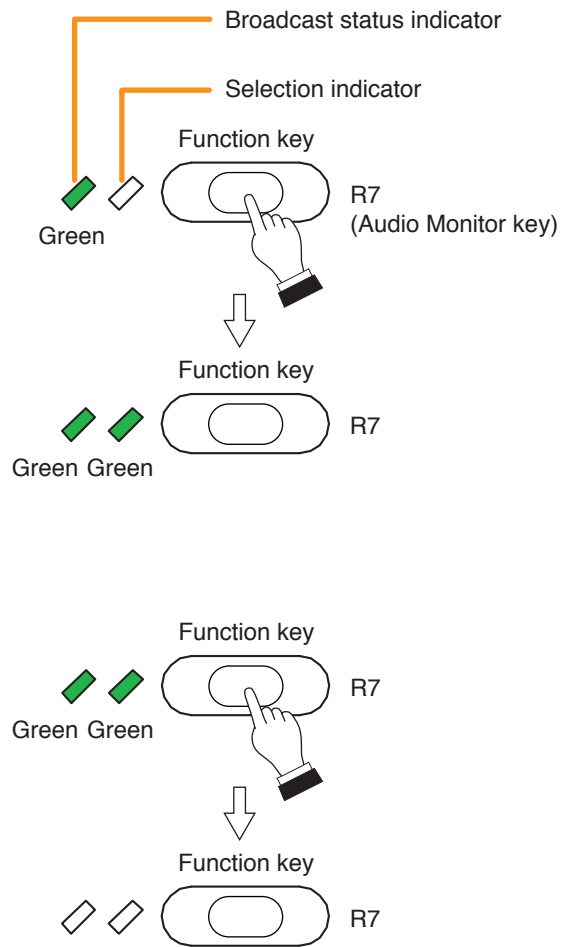

7.2. Intended Control Input Operation

The Intended control input of the VX-3000F and VX-3000PM can be operated using the Remote microphone's function key. In the same manner, this operation can also be performed with the function key on the control panel.

Step 1. Press the Intended control input key when the Control status indicator is unlit.

The control input assigned to the Intended control input key becomes active and the Control status indicator lights yellow.

Note

Operation is invalid even if you press the Intended control input key when the Control status indicator is lighting yellow though its key is not pressed. This is such a case when the control input is placed in Active state through other switch operation.

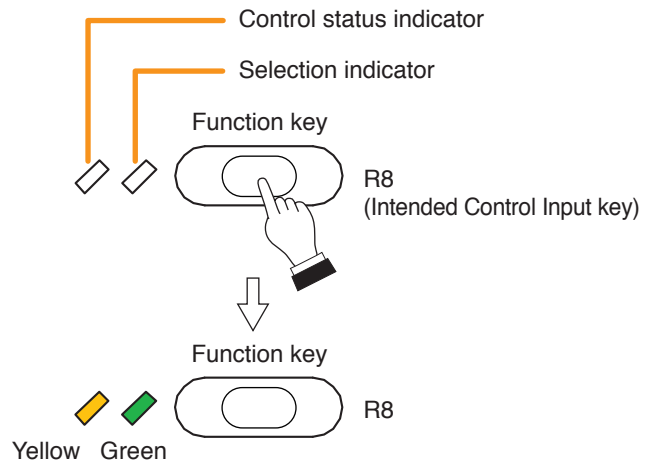

Step 2. Press the Intended control input key again to make the control input Inactive.

The Control status indicator will go off.

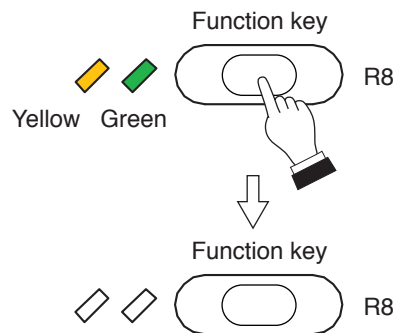

7.3. Intended Control Output Operation (Pulse)

The intended control output of the VX-3000F and VX-3000PM can be operated using the Remote microphone's function key. In the same manner, this operation can also be performed with the function key on the control panel.

Step 1. Press the Intended control output (pulse) key when the Control status indicator is unlit.

The Control output pattern assigned to the Intended control output (pulse) key is activated and the Control status indicator lights yellow.

Note

Operation is invalid even if you press the Intended control output (pulse) key when the Control status indicator is lighting yellow though its key is not pressed. This is such a case when the control output pattern is being activated by other Event.

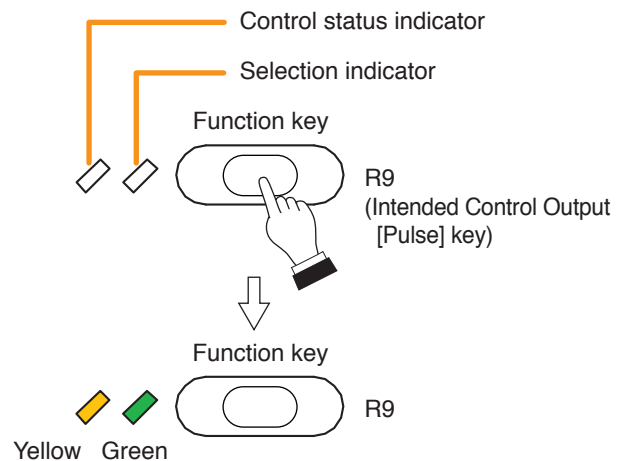

Step 2. Press the Intended control output (pulse) key again to end Control output pattern activation.

The Control status indicator will go off.

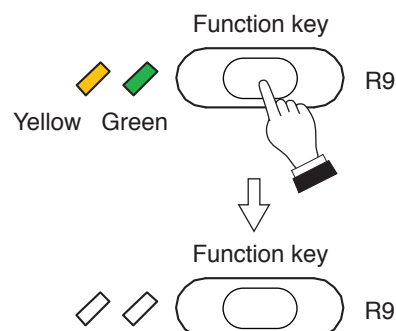

7.4. Intended Control Output Operation (Level)

The intended control output of the VX-3000F and VX-3000PM can be operated using the Remote microphone's function key.

In the same manner, this operation can also be performed with the function key on the control panel.

Step 1. Hold down the Intended control output (level) key for the time you wish to activate the control output pattern while the Control status indicator is unlit.

The Control output pattern assigned to the Intended control output (level) key is activated and the Control status indicator lights yellow.

Note

Operation is invalid even if you press the Intended control output (level) key when the Control status indicator is lighting yellow though its key is not pressed. This is such a case when the control output pattern is being activated by other Event.

Step 2. To stop the control output pattern activation, release the Intended control output (level) key. The Control status indicator will go off.

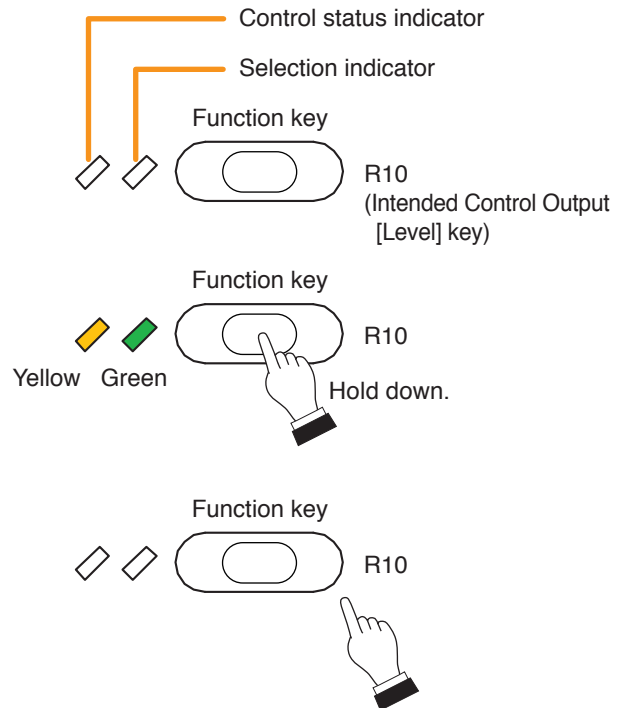

7.5. Switching VX-3000 Amplifier's Power State between Active (ON) and Sleep Modes

Using the remote microphone's function key, you can switch the VX-3000 amplifier's power state between active (ON) and sleep modes.

In the same manner, the switching operation can also be performed with the function key on the control panel. When both the status indicator and the selection indicator are unlit, the amplifier is placed in sleep mode. When either the status indicator or the selection indicator is lit, the amplifier's power is ON.

7.5.1. Turning the amplifier's power ON

Step: While both the status indicator and the selection indicator are unlit, press the Power ON key.

The selection indicator lights and the amplifier's power is turned ON.

Tip

If the sleep shift time has been set, the VX-3000F automatically returns to sleep mode when the preset time has elapsed.

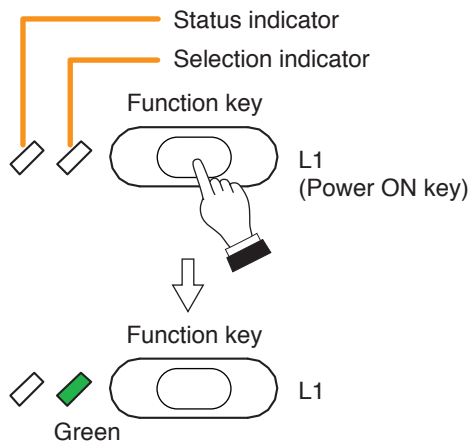

7.5.2. Placing the amplifier in sleep mode

Step: While the status indicator or the selection indicator is lighting, press the Power ON key.

The status indicator or the selection indicator that is lighting goes off, placing the amplifier in sleep mode.

Tip

Even if the sleep shift time has been set, you can forcibly return the amplifier to the sleep mode during the duration of the set time.

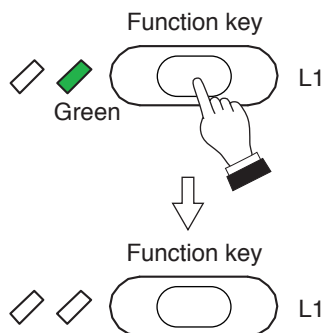

Traceability Information for Europe

Manufacturer:
TOA Corporation
7-2-1, Minatojima-Nakamachi, Chuo-ku, Kobe, Hyogo,
Japan

Authorized representative:
TOA Electronics Europe GmbH
Suederstrasse 282, 20537 Hamburg,
Germany